

# PE53210

## Document Category: Product Specification

Dual Channel Switch LNA Module, 3.3 GHz - 3.8 GHz

### Features

- Wide frequency range with internal matching
- Integrates dual-channel LNA with bypass and high power switch
- Max RF input power
  - 5W Pavg for long term
  - 10W Pavg for short term
- 1.65 dB noise figure
- 29 dBm OIP3/ 32 dB gain at full gain mode
- +105 °C operating temperature
- Low power consumption: 90 mA per channel
- Compact package size of 32-lead 5x5 mm

### Applications

- 4G/4.5G TD-LTE macro/micro cell
- Pre-5G/5G massive MIMO systems
- Receiver protection system

Figure 1 ■ PE53210 Functional Diagram

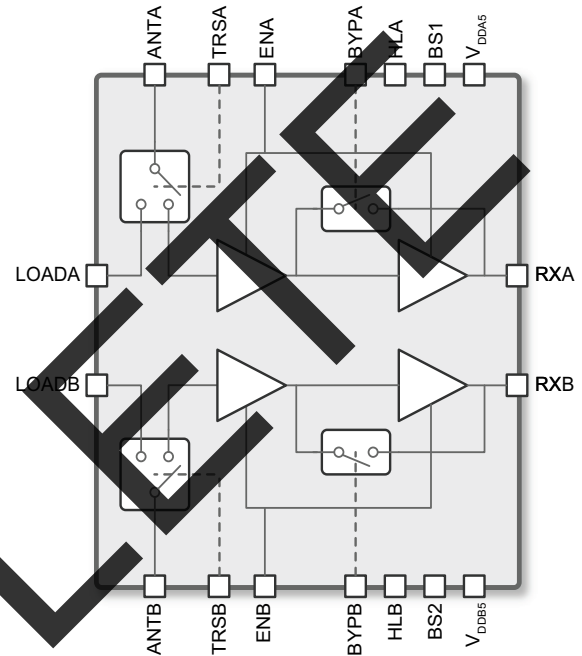

### Product Description

The PE53210 is a highly integrated front-end module targeted for wireless infrastructure applications such as TDD macro/micro base stations and MIMO applications. It is designed for use at the front end of a receiver chain for TDD-based systems. The PE53210 is ideally suited for 4G or next-generation 5G solutions, or small cell applications.

The dual-channel receiver integrates two independent LNAs with bypass function and a high power switch. The PE53210 can be utilized across the 3.3–3.8 GHz frequency range with internal impedance matching networks.

This receiver utilizes pSemi's UltraCMOS SOI technology which supports input RF power signal up to 5W average power, assuming 8 dB PAR and very low noise figure, excellent linearity and very low power consumption. Each channel is controlled individually within the selected frequency band, which allows more flexibility in the system design.

## Absolute Maximum Ratings

Exceeding absolute maximum ratings listed in **Table 1** may cause permanent damage. Operation should be restricted to the limits in **Table 2**. Operation between operating range maximum and absolute maximum for extended periods may reduce reliability.

### ESD Precautions

When handling this UltraCMOS device, observe the same precautions as with any other ESD-sensitive devices. Although this device contains circuitry to protect it from damage due to ESD, precautions should be taken to avoid exceeding the rating specified in **Table 1**.

Table 1 ■ Absolute Maximum Ratings for PE53210

Parameter	Rating	Unit
Power supply voltage	5.50	V
Control input voltage	3.60	V
Storage temperature range	-65 to 150	°C
RF input power, single event, average <sup>(1)</sup>	40	dBm
LNA input power	22	dBm
Human-body model, all pins <sup>(2)</sup>	1000	V
Charged device model, all pins <sup>(3)</sup>	500	V
1) TX mode, 10 min duration, 105 °C, 8 dB PAR LTE signal, no hot switching 2) Human body model (MIL-STD 883 Method 3015) 3) Charged device model (JEDEC JESD22-C101)		

## Recommended Operating Conditions

**Table 2** lists the recommending operating conditions for the PE53210. Devices should not be operated outside the recommended operating conditions listed below.

Table 2 ■ Recommended Operating Conditions for PE53210

Parameter	Min	Typ	Max	Unit
V <sub>DD</sub> positive supply voltage	4.75		5.25	V
Control voltage high	1.17		3.60	V
Control voltage low	-0.30		0.60	V
Digital input leakage current	-20	0	20	μA
Operating temperature range	-40	25	105	°C

## Electrical Specifications

Table 3 provides the PE53210 key electrical specifications @ +25 °C,  $V_{DD} = 5V$  ( $Z_S = Z_L = 50\Omega$ ), unless otherwise specified.

Table 3 ■ PE53210 Electrical Specifications

Parameter	Condition	Min	Typ	Max	Unit
Frequency range		3300		3800	MHz
Input return loss	ANTA or ANTB, Rx mode at 3300 MHz at 3500 MHz at 3800 MHz		12.5 20 10		dB
Output return loss	At RXA or RXB, Rx mode at 3300 MHz at 3500 MHz at 3800 MHz		7 8.5 8		dB
Insertion loss	Tx operation mode, ANT-Load		0.7		dB
RF max input power (Pavg)	Average value; No damage for long time operation; RF Load connected to load with -10dB return loss. LTE Signal PAR 8dB	5			W
TX/RX switching time	RX to TX or TX to RX, 50% cntl to 10/90 RF		550		ns
Bypass switching time	Bypass enable or disable, 50% cntl to 10/90 RF		220		ns
Switch isolation	RX mode ANT to load termination		20		dB
Switch isolation	TX mode, LNA off, ANT to RX OUT		60		dB
Channel isolation	RX mode, RX to RX		38		dB
Channel isolation	TX mode, TX to TX		46		dB
Cross isolation	RX mode, ANT1 to RX2		73		dB
Cross isolation	RX mode, LNA 2 bypass, ANT1 to RX2		60		dB
In-band spurious emission	Rx mode at Rx out with pin = -49 dBm Pin is a CW signal swept across frequency range. Spec refers to any spurious mixing product that occurs across frequency range.		-85		dBc
Out-of-band emission	Rx mode at Rx out from DC to 12275 MHz Measure Pout with IBW = 4.5 MHz over frequency range with no input power applied.		-65		dBm
<b>Full Gain Mode</b>					
Supply current	5V supply, per channel, at max gain		90		mA
Bypass mode supply current	5V supply, per channel, second amp bypassed		25		mA
Gain	Full gain mode at 3300 MHz at 3500 MHz at 3800 MHz	31 29 26.5	32 30.5 28	33.6 31.9 29.8	dB
Gain flatness	Full gain mode		0.8		dB
Bypass gain	Bypass mode	11.7	14		dB
Bypass gain flatness	Full gain mode		0.6		dB

Table 3 ■ PE53210 Electrical Specifications (Cont.)

Parameter	Condition	Min	Typ	Max	Unit
NF	Full gain or bypass mode		1.65	1.9	dB
OIP3 <sup>(1)</sup>	Full gain mode	28	29		dBm
Bypass OIP3 <sup>(2)</sup>	Bypass mode	22	24		dBm
OP1dB	Full gain mode		19		dBm
Bypass OP1dB	Bypass mode		13		dBm
<b>Low Power Mode</b>					
Low power mode current	5V supply, per channel		75		mA
Bypass mode supply current	5V supply, per channel, second amp bypassed		25		mA
Gain	Full gain mode	26.5	28		dB
Gain flatness	Any 100 MHz bandwidth, at full gain		0.75		dB
Bypass gain	Bypass mode	12	14		dB
Bypass gain flatness	Any 100 MHz bandwidth, second amp bypassed		0.75		dB
NF	Full gain or bypass mode		1.65	1.90	dB
OIP3 <sup>(1)</sup>	Full gain mode	26	27.5		dBm
Bypass OIP3 <sup>(2)</sup>	Bypass mode	21.5	23.5		dBm
OP1dB	Max gain mode		19		dBm
Bypass OP1dB	Bypass mode		13		dBm
1) -35 dBm input power, 1 MHz tone spacing 2) -25 dBm input power, 1 MHz tone spacing					

OBSOLETE

## Typical Performance Data

Figure 2 through Figure 18 show the typical performance data at nominal condition, unless otherwise specified.

Figure 2 ■ *Gain vs. Frequency (Rx Full Gain Mode)*

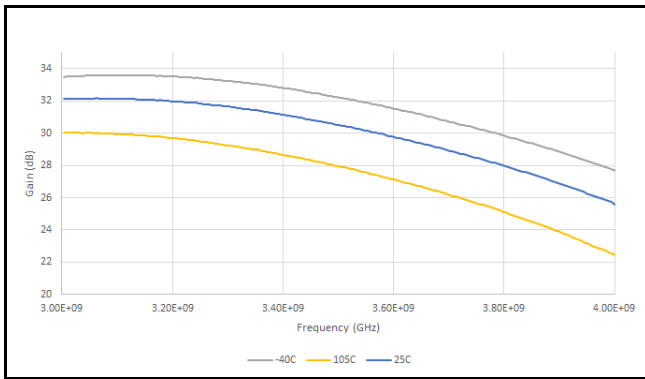

Figure 3 ■ *ANT Return Loss vs. Frequency (Rx Full Gain Mode)*

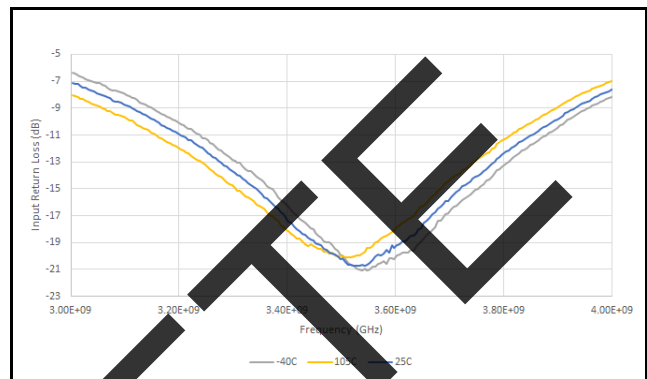

Figure 4 ■ *Rx Out Return Loss vs. Frequency (Rx Full Gain Mode)*

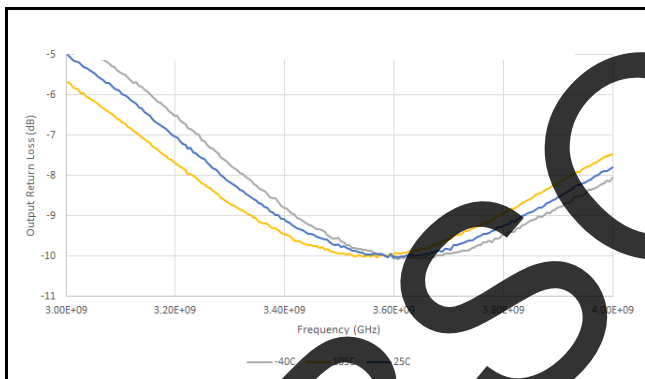

Figure 5 ■ *Noise Figure vs. Frequency (Rx Full Gain Mode)*

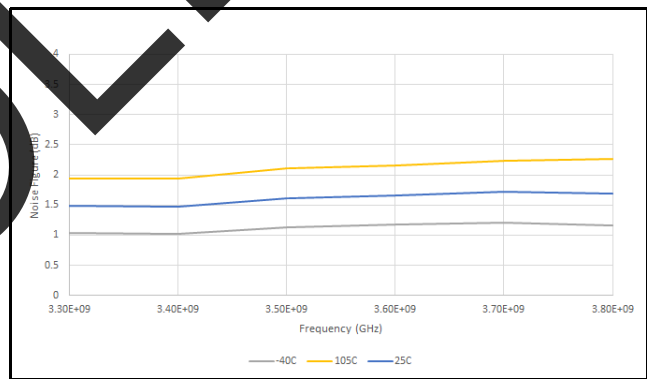

Figure 6 ■ *OIP3 vs. Frequency (Rx Full Gain Mode)*

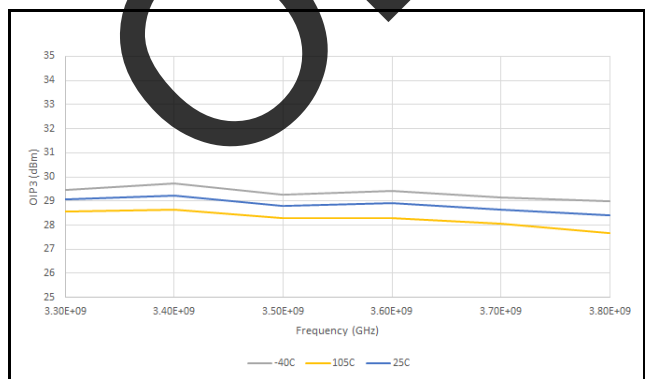

Figure 7 ■ *Output P1dB vs. Frequency (Rx Full Gain Mode)*

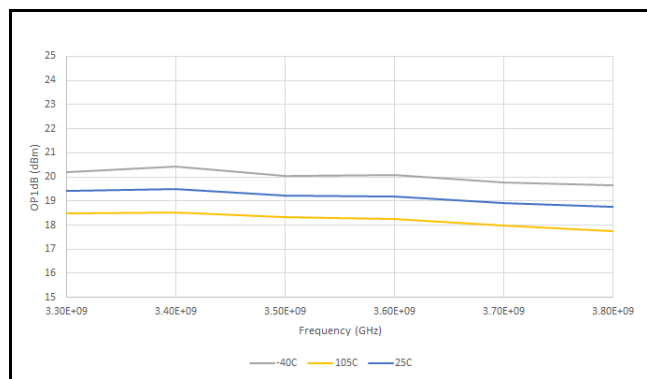

Figure 8 ■ *CH-CH Isolation vs. Frequency (Rx Full Gain Mode)*

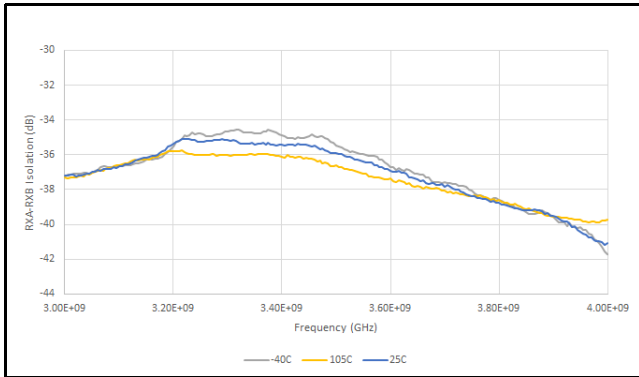

Figure 9 ■ *Gain Over Temp vs. Frequency (Rx Bypass Mode)*

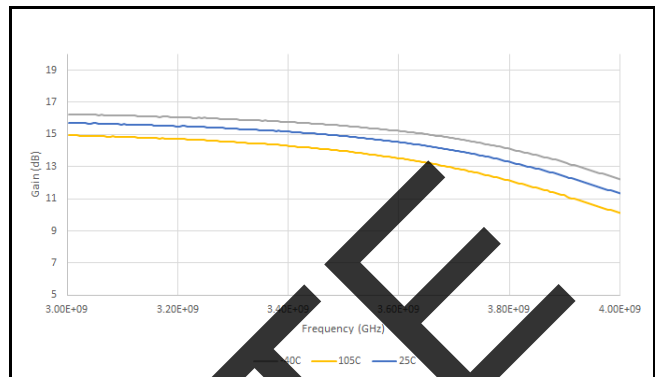

Figure 10 ■ *ANT Return Loss Over Temp vs. Frequency (Rx Bypass Mode)*

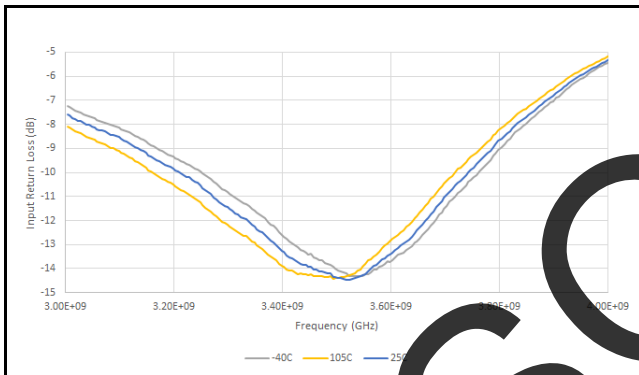

Figure 11 ■ *Rx Out Return Loss Over Temp vs. Frequency (Rx Bypass Mode)*

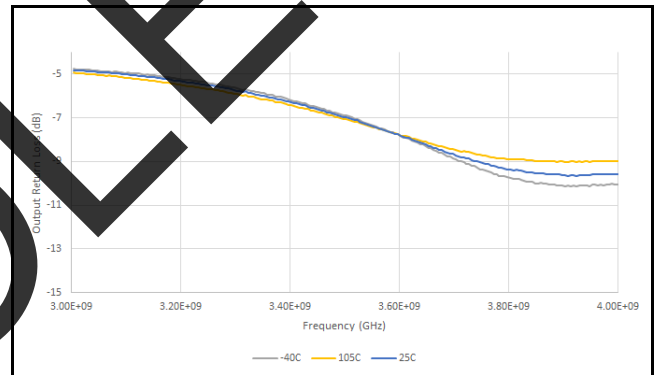

Figure 12 ■ *Noise Figure Over Temp vs. Frequency (Rx Bypass Mode)*

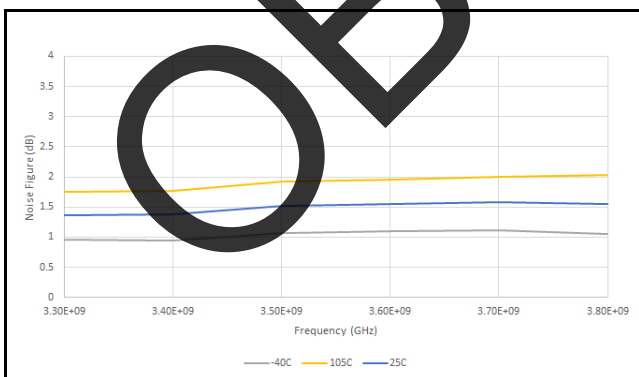

Figure 13 ■ *OIP3 Over Temp vs. Frequency (Rx Bypass Mode)*

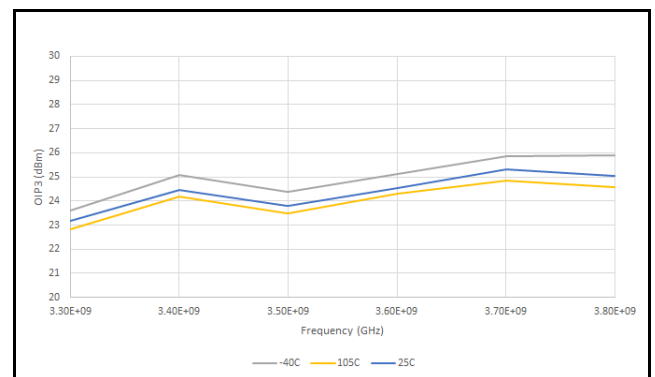

Figure 14 ■ **Output P1dB Over Temp vs. Frequency (Rx Bypass Mode)**

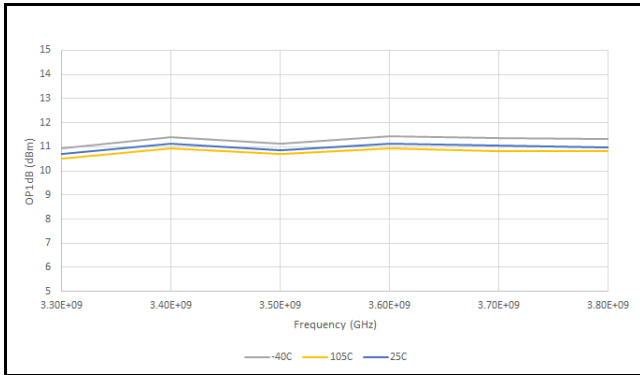

Figure 15 ■ **CH-CH Isolation Over Temp vs. Frequency (Rx Bypass Mode)**

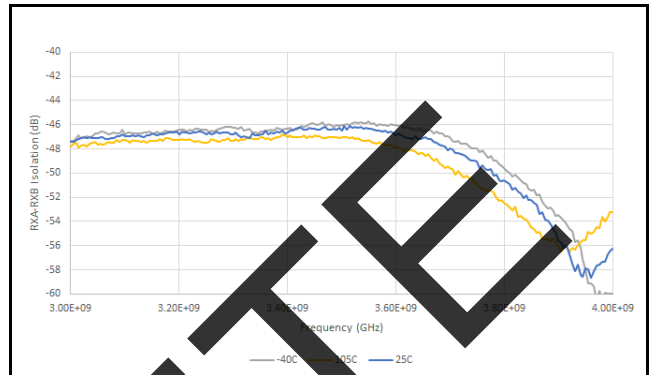

Figure 16 ■ **Insertion Loss vs. Frequency (Tx Mode)**

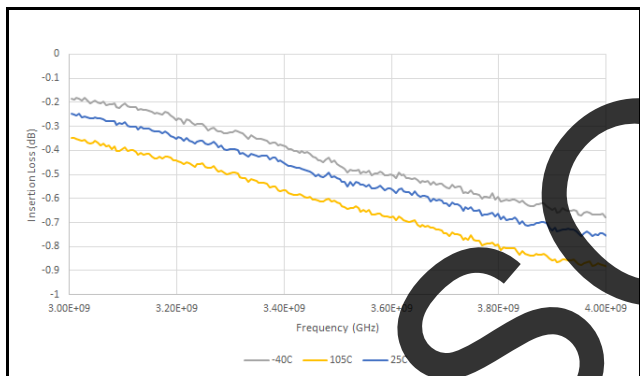

Figure 17 ■ **ANT Return Loss vs. Frequency (Tx Mode)**

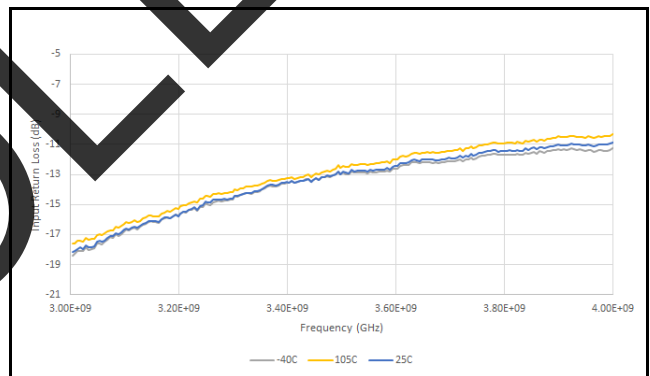

Figure 18 ■ **Rx Out Return Loss vs. Frequency (Tx Mode)**

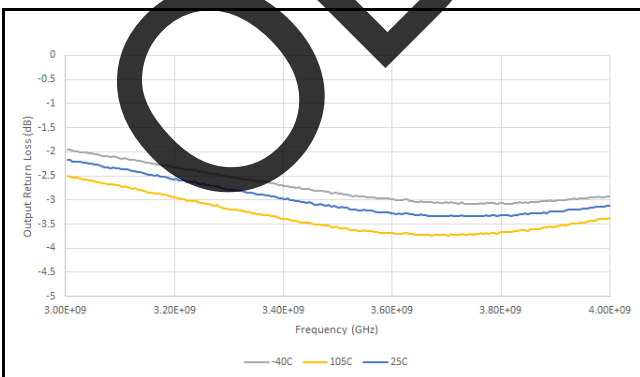

Figure 19 ■ **ANT-Rx Isolation vs. Frequency (Tx Mode)**

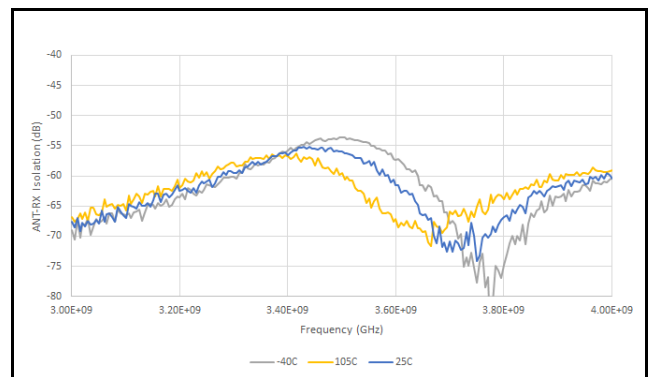

Figure 20 ■ *ANT-Load Isolation vs. Frequency (Rx Mode)*

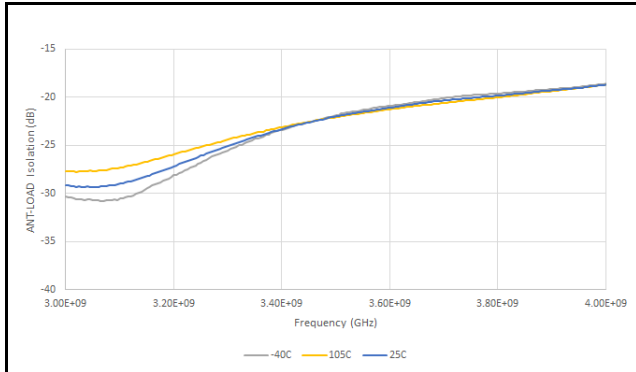
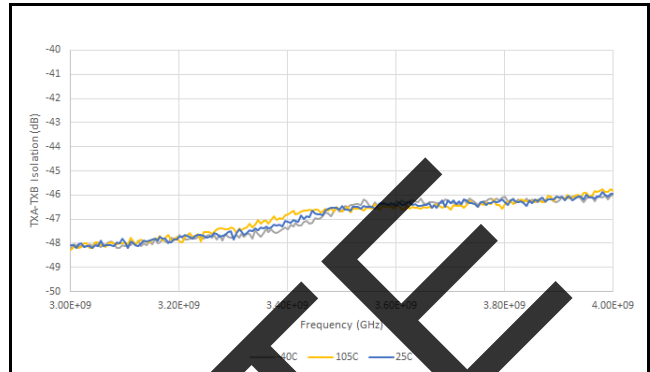

Figure 21 ■ *CH-CH Isolation vs. Frequency (Tx Mode)*



## Supply Current vs. Resistor Value

Table 4 ■ Supply Current vs. Resistor Value

Part Number	Resistor Value	Supply Current— Rx Full Gain Mode	Supply Current— Rx Bypass Mode
PE53210/PE53211	120 K $\Omega$ (R9, R10)	90 mA	25 mA
	200 K $\Omega$ (R9, R10)	75 mA	25 mA
PE53110/PE53111	120 K $\Omega$ (R9)	90 mA	25 mA
	200 K $\Omega$ (R9)	75 mA	25 mA



## Pin Configuration

This section provides pin information for the PE53210. **Figure 22** shows the pin configuration of this device. **Table 5** provides a description for each pin.

Figure 22 ■ Pin Configuration (Top View)

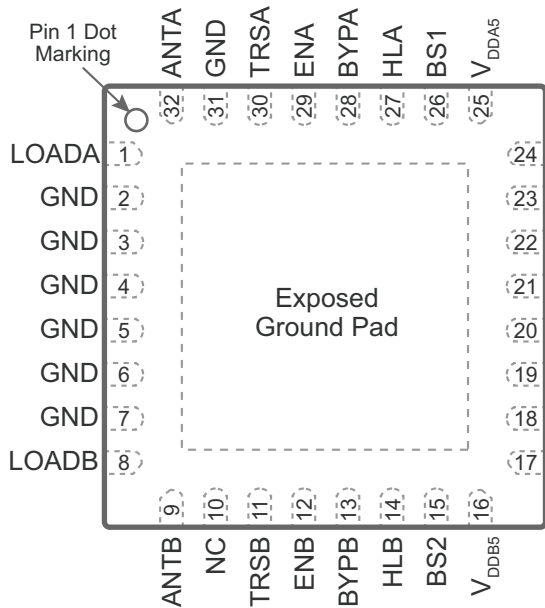

Table 5 ■ Pin Descriptions for PE53210

Pin No.	Pin Name	Description
1	LOADA	Channel A load
2-7, 18-23, 31	GND	Ground
8	LOADB	Channel B load
9	ANTB	Channel B antenna
10	NC	Not connected. Pin 10 (NC) must be left NOT CONNECTED at the application board for proper operation.
11	TRSB	Channel B high power switch control
12	ENB	Channel B LNA enable
13	BYPB	Channel B LNA bypass control
14	HLB	Channel B bias. HLB requires a 120k Ohm resistor to the application board GND to set 90 mA in Rx Full Gain mode, BYPA=0.
15	BS2	Isolation. BS2 can be left NOT CONNECTED for internally-tied logic high. If BS2 is connected to the TRSB control pin, it will improve ANTB to RXB isolation in TX mode for channel B.
16	V <sub>DDB5</sub>	Supply voltage
17	RXB	Channel B RF output port External 39pF DC blocking capacitor is required.
24	RXA	Channel A RF output port External 39pF DC blocking capacitor is required.
25	V <sub>DDA5</sub>	Supply voltage
26	BS1	Isolation. BS1 can be left NOT CONNECTED for internally-tied logic high. If BS1 is connected to the TRSA control pin, it will improve ANTA to RXA isolation in TX mode for channel A.

Table 5 ■ Pin Descriptions for PE53210 (Cont.)

Pin No.	Pin Name	Description
27	HLA	Channel A bias. HLA requires a 120k Ohm resistor to the application board GND to set 90 mA in Rx Full Gain mode, BYPA=0.
28	BYPA	Channel A LNA bypass control
29	ENA	Channel A LNA enable
30	TRSA	Channel A high power switch control
32	ANTA	Channel A antenna
PAD	GND	Exposed pad: ground for proper operation

## Truth Table

Table 6 ■ Receiver Module Dual Channel Tx-Rx Control Logic Truth Table

Mode	BS1	BS2	ENA	ENB	TRSA	TRSB	BYPA	BYPB
Receive—Full Gain	1	1	1	1	1	1	0	0
Receive—Bypass	1	1	1	1	1	1	1	1
Transmit	1	1	0	0	0	0	0	0

## Packaging Information

This section provides packaging data including the moisture sensitivity level, package drawing, package marking and tape-and-reel information.

### Moisture Sensitivity Level

The moisture sensitivity level rating for the PE53210 in the 32-lead 5 × 5 × 0.71 mm LGA package is MSL 3.

### Package Drawing

Figure 23 ■ Package Mechanical Drawing for 32-lead 5 × 5 × 0.71 mm LGA

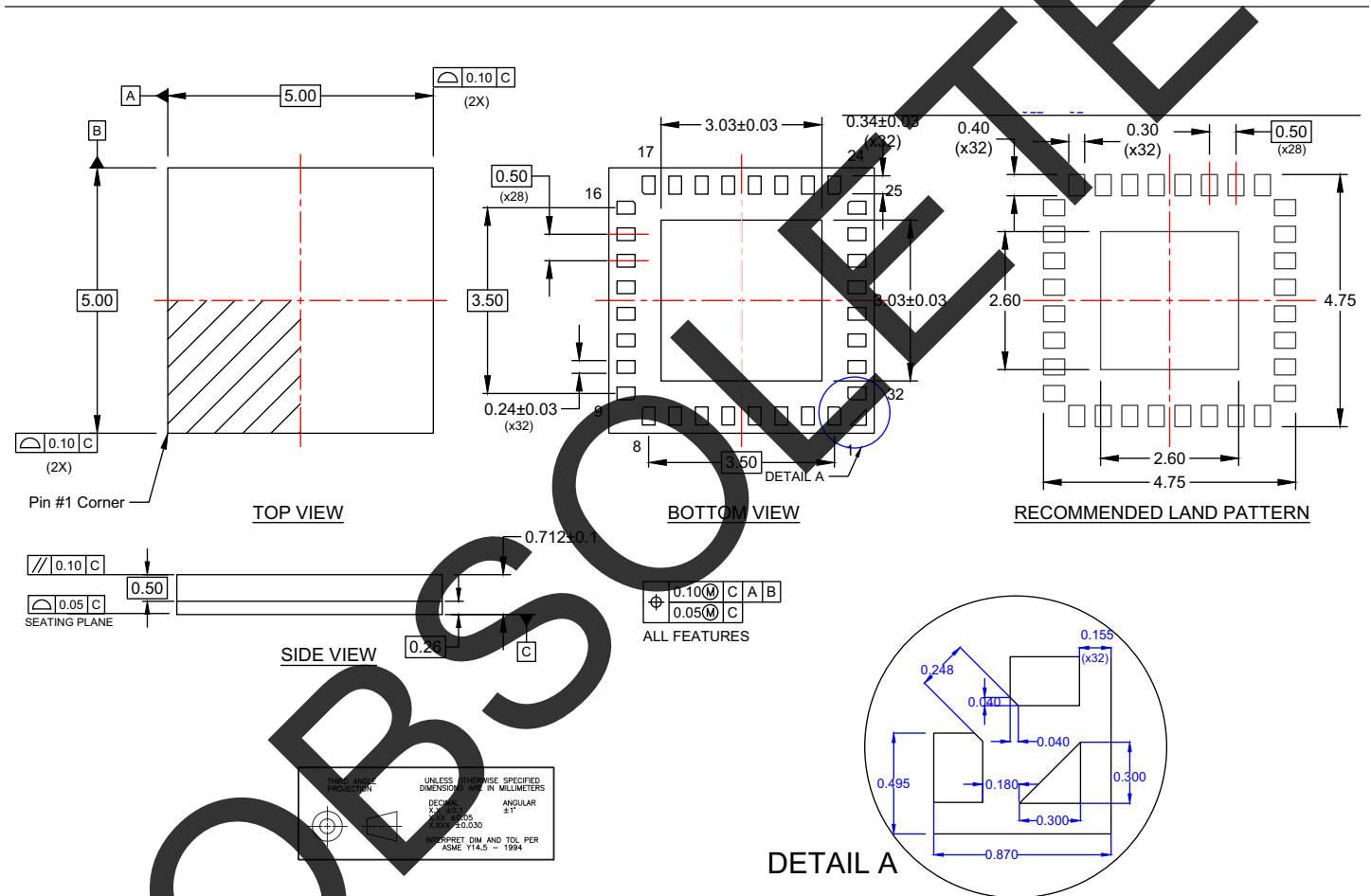

## Top-Marking Specification

Figure 24 ■ Package Marking Specifications for PE53210

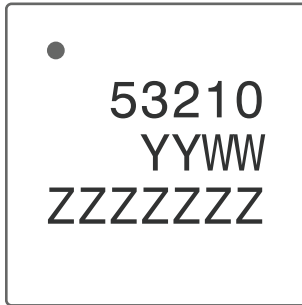

- = Pin 1 indicator
- YY = Last two digits of assembly year
- WW = Assembly work week
- ZZZZZZZ = Assembly lot code (maximum seven characters)

**OBSOLETE**

## Tape and Reel Specification

Figure 25 ■ Tape and Reel Specification for PE53210

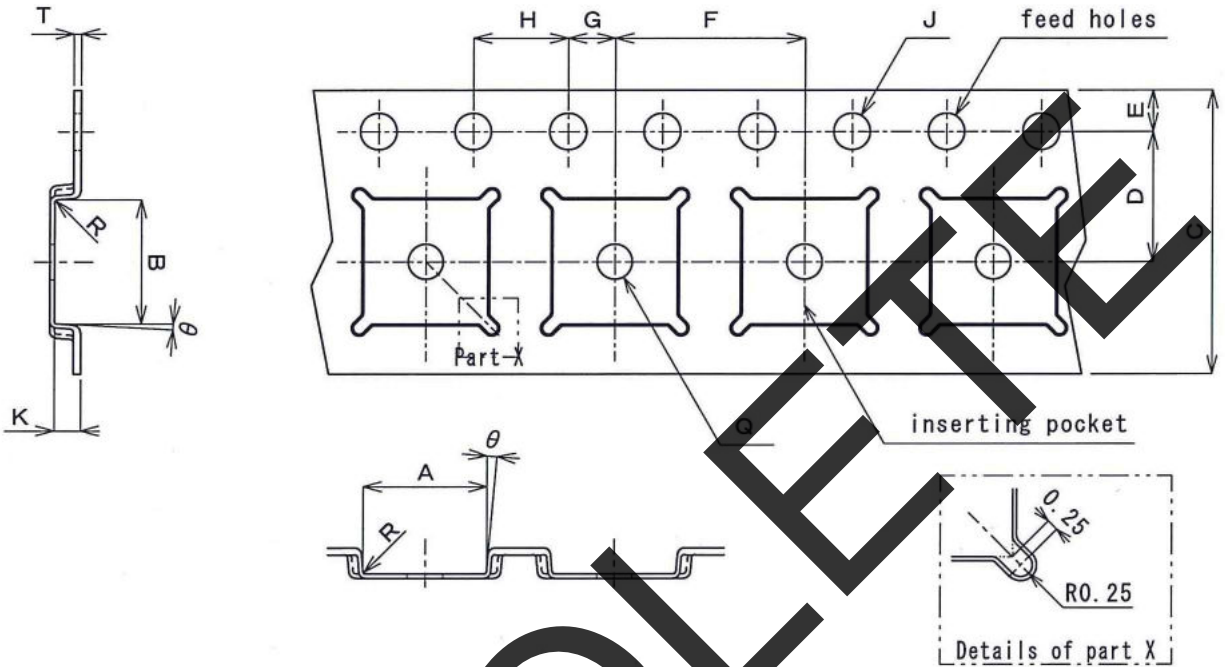

symbol	A	B	C	D	E	F	G
size	$5.25 \pm 0.10$	$5.25 \pm 0.10$	$12.00^{+0.30}_{-0.10}$	$5.50 \pm 0.05$	$1.75 \pm 0.10$	$8.00 \pm 0.10$	$2.00 \pm 0.05$

symbol	H	J	K	Q	T	R	$\theta$
size	$4.00 \pm 0.10$	$1.50^{+0.10}_0$	$1.10 \pm 0.10$	$1.50^{+0.10}_0$	$0.30 \pm 0.05$	0.30max	$5.00^\circ$ max

※accumulation 10pitch(10H)  $40.0 \pm 0.20$ mm

※A, B, dimensions are in base dimensions  
(see the figure on the right)

◎K dimensions are measured with depth gauge.

T dimensions are measured with caliper

Other dimensions are measured with a projector.

◎Do not enter R,  $\theta$  measurements in inspection date  
as reference values.

◎D, G dimensions shall be pocket center values.

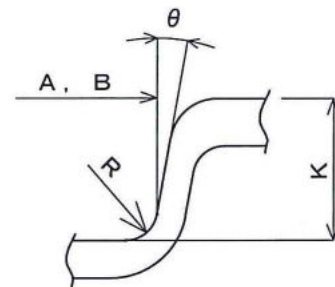

inside of the pocket R detail drawing

## Ordering Information

Table 7 lists the available ordering codes for the PE53210 as well as available shipping methods.

Table 7 ■ Order Codes for PE53210

Order Codes	Description	Packaging	Shipping Method
PE53210A-Z	PE53210 Switch and LNA	32-lead 5x5 mm LGA	3000 units/T&R
EK53210-01	PE53210 Evaluation kit	Evaluation kit	1/Box

## Document Categories

### Advance Information

The product is in a formative or design stage. The datasheet contains design target specifications for product development. Specifications and features may change in any manner without notice.

### Preliminary Specification

The datasheet contains preliminary data. Additional data may be added at a later date. pSemi reserves the right to change specifications at any time without notice in order to supply the best possible product.

### Product Specification

The datasheet contains final data. In the event pSemi decides to change the specifications, pSemi will notify customers of the intended changes by issuing a CNF (Customer Notification Form).

### Sales Contact

For additional information, contact Sales at [sales@psemi.com](mailto:sales@psemi.com).

### Disclaimers

The information in this document is believed to be reliable. However, pSemi assumes no liability for the use of this information. Use shall be entirely at the user's own risk. No patent rights or licenses to any circuits described in this document are implied or granted to any third party. pSemi's products are not designed or intended for use in devices or systems intended for surgical implant, or in other applications intended to support or sustain life, or in any application in which the failure of the pSemi product could create a situation in which personal injury or death might occur. pSemi assumes no liability for damages, including consequential or incidental damages, arising out of the use of its products in such applications.

### Patent Statement

pSemi products are protected under one or more of the following U.S. patents: [patents.psemi.com](http://patents.psemi.com)

### Copyright and Trademark

©2017, 2018, pSemi Corporation. All rights reserved. The Peregrine Semiconductor name, Peregrine Semiconductor logo and UltraCMOS are registered trademarks and the pSemi name, pSemi logo, HaRP and DuNE are trademarks of pSemi Corporation in the U.S. and other countries.