

PE42920

**UltraCMOS® Passive DDSPDT
High-Isolation RF Switch
10 kHz–6 GHz**

Features

- Dual differential single pole double throw switch
- Broadband: 10 kHz to 6 GHz
- Low frequency insertion loss: 0.7 dB typical
- High isolation between same channels at 6 GHz: 26 dB typical
- High isolation between opposite active channels at 6 GHz: 30 dB typical
- Low phase mismatch between matched paths at 6 GHz: 15 degrees typical
- High ESD performance: 2 kV HBM

Product Description

The PE42920 is a dual differential single pole double throw (DDSPDT) RF switch developed on Peregrine’s UltraCMOS® process technology. It is a broadband and low loss device enabling the switching of two independent differential signals. This device consumes less power than active differential switches and offers 2 kV HBM ESD protection. It has high isolation between same channel inputs as well as opposite active channels. It has been designed for low phase mismatch between matched paths.

The PE42920 is manufactured on Peregrine’s UltraCMOS process, a patented variation of silicon-on-insulator (SOI) technology on a sapphire substrate, offering the performance of GaAs with the economy and integration of conventional CMOS.

Figure 2. Package Type
16-lead 3 × 3 mm QFN

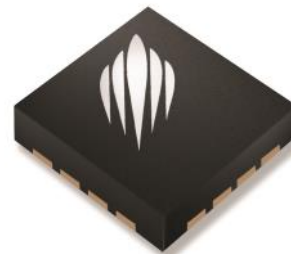
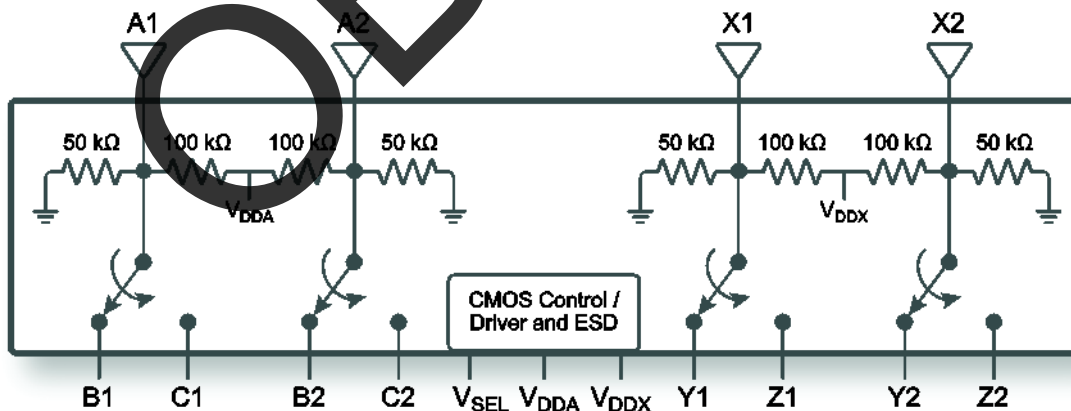

Figure 1. Functional Diagram



Note: Differential pairs B1/B2 and Y1/Y2 must be switched simultaneously to pairs C1/C2 and Z1/Z2. See Table 5, Truth Table.

DOC-52427

Table 1. Typical Specifications $V_{DD} = 3.3V$, Temp = +25 °C ($Z_S = Z_L = 100\Omega$ differential)
Min/Max Specifications $V_{DD} = 3.3V \pm 10\%$, $-40\text{ °C} \leq \text{Temp} \leq +85\text{ °C}$, ($Z_S = Z_L = 100\Omega$ differential)

AC coupled – external DC blocking caps

Electrical Parameter	Condition/Notes		Min	Typ	Max	Unit
Operating frequency	Frequency range		10 kHz		6 GHz	As shown
	Differential 3 dB bandwidth		5.6	6		GHz
Insertion loss at 10 kHz	$V_{CM} = 1.1V$			0.7	1.25	dB
Insertion loss at 1 GHz	$V_{CM} = 1.1V$			1.0	1.4	dB
Isolation between same channel inputs at 6 GHz	A to C when B is ON. A to B when C is ON X to Z when Y ON. X to Y when Z is ON		24	26		dB
Isolation between opposite (active) channels at 6 GHz	Channels A \leftrightarrow X. $V_{CM} = 1.1V$		25	30		dB
Input 1dB compression* (P_{1dB})	$V_{CM} = 1.1V$, differential		10	13		dBm
Return loss common ports A and X	Differential	50–1250 MHz	12.5	14		dB
		1250–2500 MHz	8	9		dB
		2500–4000 MHz	5.5	8		dB
	Single ended	50–1250 MHz	14.5	17.5		dB
		1250–2500 MHz	12	14		dB
		2500–4000 MHz	10.5	13		dB
Return loss active ports B, C, Y, Z	Differential	50–1250 MHz	12.5	15.5		dB
		1250–2500 MHz	8.5	9.5		dB
		2500–4000 MHz	8	9.5		dB
	Single ended	50–1250 MHz	16	18.5		dB
		1250–2500 MHz	13	16		dB
		2500–4000 MHz	10.5	14.5		dB
Switching time	50% control to 10/90% RF			270	450	ns
Phase mismatch on matched paths at 6 GHz	$V_{SEL} = 1$ matched paths (A1 \leftrightarrow B1 & A2 \leftrightarrow B2) (X1 \leftrightarrow Y1 & X2 \leftrightarrow Y2)	$V_{SEL} = 0$ matched paths (A1 \leftrightarrow C1 & A2 \leftrightarrow C2) (X1 \leftrightarrow Z1 & X2 \leftrightarrow Z2)	$V_{CM} = 1.1V$	15	30	degrees
Phase mismatch on un-matched paths at 6 GHz	Unmatched: average of A1,A2 delay to average of X1,X2		$V_{CM} = 1.1V$	22	50	degrees
Phase delta stability	Across voltage and temperature				2	degrees
Common mode voltage	Common port self biased V_{CM} ($V_{cm} \approx V_{DD}/3$)			1.1		V
Common mode impedance	Common port bias resistances	Z_{CM} to V_{DD}		100		k Ω
		Z_{CM} to GND		50		k Ω
Input IP3	Single ended (see Figure 19)					dBm
Note: * P_{1dB} is an indication of device linearity, max operating power is restricted to limits in Table 3.						

Figure 3. Pin Configuration (Top View)

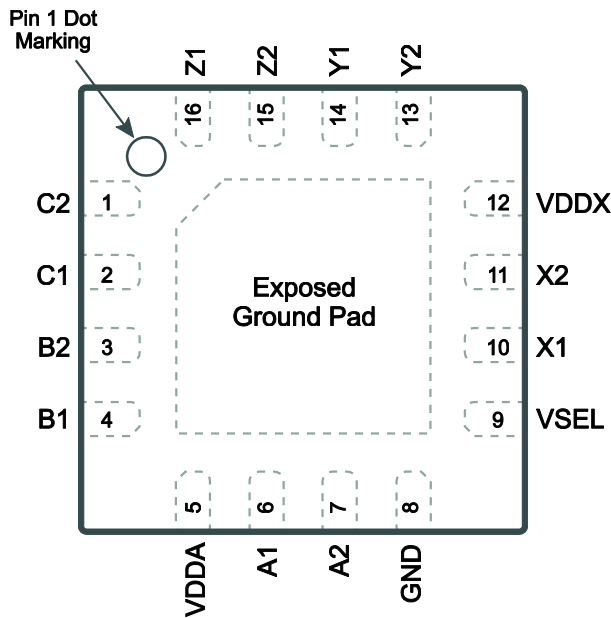

Table 2. Pin Descriptions

Pin No.	Pin Name	Description
1	C2	C-channel [Logic Low] RF Port –
2	C1	C-channel [Logic Low] RF Port +
3	B2	B-channel [Logic High] RF Port –
4	B1	B-channel [Logic High] RF Port +
5	VDDA	A-channel Supply
6	A1	A-channel RF Common Port +
7	A2	A-channel RF Common Port –
8	GND	Ground
9	VSEL	Simultaneous Logic Select
10	X1	X-channel RF Common Port +
11	X2	X-channel RF Common Port –
12	VDDX	X-channel Supply
13	Y2	Y-channel [Logic High] RF Port –
14	Y1	Y-channel [Logic High] RF Port +
15	Z2	Z-channel [Logic Low] RF Port –
16	Z1	Z-channel [Logic Low] RF Port +
Paddle	GND	Exposed solder pad: Ground for proper operation

Table 3. Operating Ranges²

Parameter	Min	Typ	Max	Unit
V _{DD} ¹ Power Supply Voltage	2.97	3.3	3.63	V
I _{DD} Supply Current		100	500	μA
T _{OP} Operating Temperature	–40		85	°C
P _{DC} DC Power Consumption			2	mW
V _{IH} V _{SEL} Control Voltage High	0.7xV _{DD}		V _{DD}	V
V _{IL} V _{SEL} Control Voltage Low	0		0.3xV _{DD}	V
I _{IH/IL} I _{SEL} Control Current Input High/Low			1	μA
P _{MAX} Max. Input Power (100Ω Differential, Active Port)			10	dBm
P _{MAX} Max. Input Power (50Ω Single Ended, Active Port)			7	dBm
V _{PEAK-TO-PEAK} Max Input Differential (100Ω) Single Ended (50Ω)			2.8 1.4	V _{PP} V _{PP}

Notes: 1. Operating below min. V_{DD} results in degraded performance.
2. Operation should be restricted to the limits in the Operating Ranges table.

Table 4. Absolute Maximum Ratings

Parameter/Condition	Min	Max	Unit
P _{MAX} Max. Input Power (100Ω Differential, Active Port)		10	dBm
P _{MAX} Max. Input Power (50Ω Single Ended, Active Port)		7	dBm
V _{SEL} Control Voltage		4	V
I _{SW} DC Current on RF Path		5	mA
T _{ST} Storage Temperature	–65	+150	°C
V _{ESD} HBM ESD Voltage ¹		2000	V
V _{ESD} MM ESD Voltage ²		100	V
V _{PEAK-TO-PEAK} Max Input Differential (100Ω) Single Ended (50Ω)		2.8 1.4	V _{PP} V _{PP}

Notes: 1. HBM ESD Voltage (HBM, MIL-STD 883, Method 3015.7).
2. MM ESD Voltage (JESD22-A115-A).

Exceeding absolute maximum ratings may cause permanent damage. Operation between operating range maximum and absolute maximum for extended periods may reduce reliability.

Electrostatic Discharge (ESD) Precautions

When handling this UltraCMOS device, observe the same precautions that you would use with other ESD-sensitive devices. Although this device contains circuitry to protect it from damage due to ESD, precautions should be taken to avoid exceeding the

Latch-Up Avoidance

Unlike conventional CMOS devices, UltraCMOS devices are immune to latch-up.

Moisture Sensitivity Level

The Moisture Sensitivity Level rating for the PE42920 in the 16-lead 3 × 3 mm QFN package is MSL1.

Table 5. Truth Table: Signal-Path Control Logic

Path	Channel A		Channel X	
	A→B	A→C	X→Y	X→Z
Low	OFF	ON	OFF	ON
High	ON	OFF	ON	OFF

A = Differential pair A1/A2
 C = Differential pair C1/C2
 Y = Differential pair Y1/Y2

B = Differential pair B1/B2
 X = Differential pair X1/X2
 Z = Differential pair Z1/Z2

OBSOLETE

Typical Performance Data @ 3.3V and +25 °C, unless otherwise specified

Figure 4. Differential Insertion Loss over V_{DD}

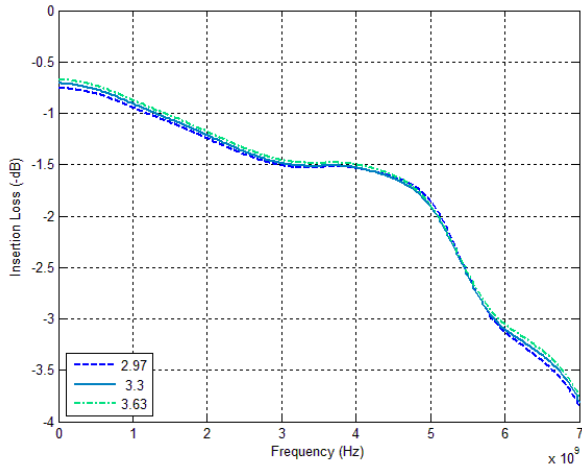

Figure 5. Differential Insertion Loss over Temp

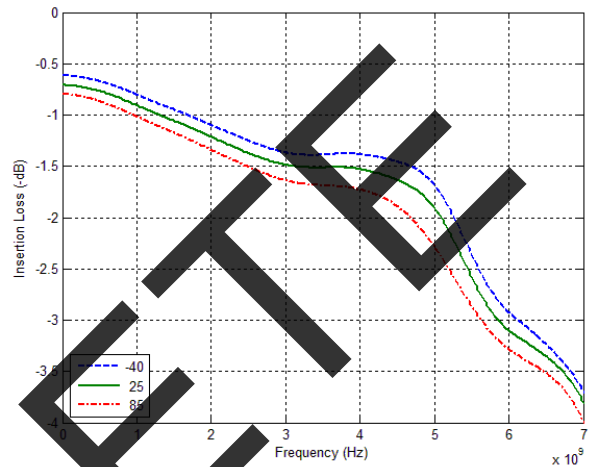

Figure 6. Differential Active Port (B, C, Y, or Z) Return Loss over V_{DD}

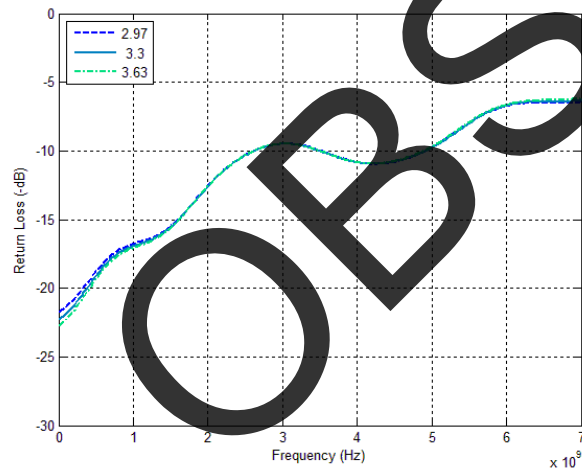
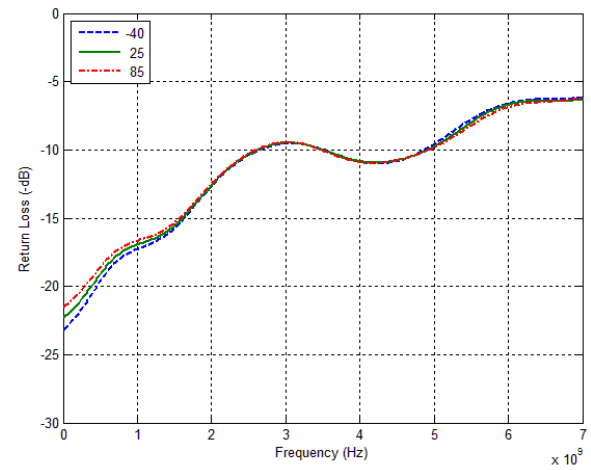

Figure 7. Differential Active Port (B, C, Y, or Z) Return Loss over Temp



OBSOLETE

Typical Performance Data @ 3.3V and +25 °C, unless otherwise specified

Figure 8. Differential Common Port (A or X) Return Loss over V_{DD}

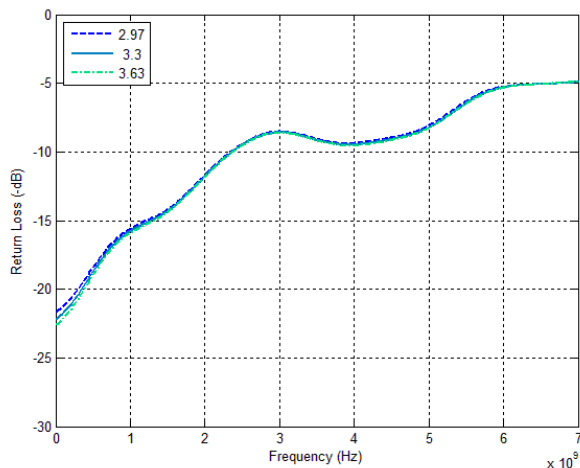

Figure 9. Differential Common Port (A or X) Return Loss over Temp

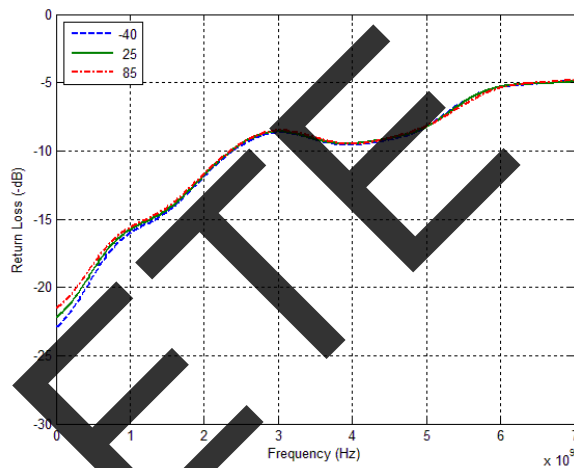

Figure 10. Single-Ended Active Port (B1, B2, C1, C2, Y1, Y2) Return Loss over V_{DD}

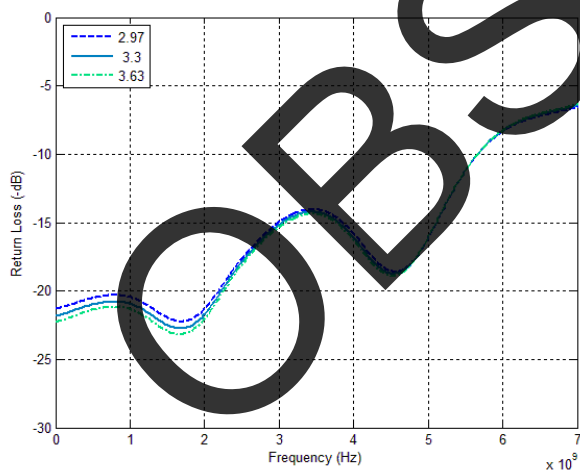
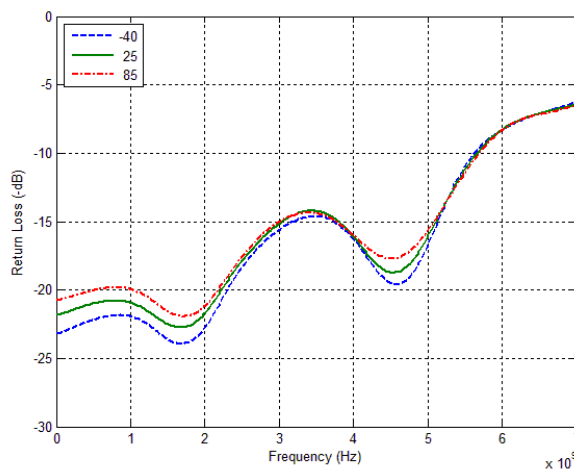

Figure 11. Single-Ended Active Port (B1, B2, C1, C2, Y1, Y2) Return Loss over Temp



Typical Performance Data @ 3.3V and +25 °C, unless otherwise specified (cont.)

Figure 12. Single-Ended Common Port (A1, A2, X1, X2) Return Loss over V_{DD}

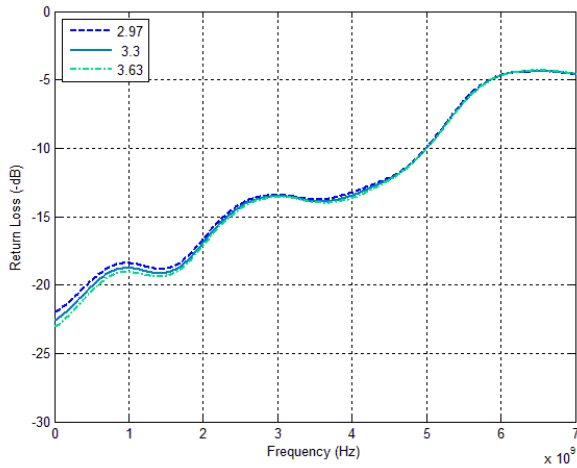

Figure 13. Single-Ended Common Port (A1, A2, X1, X2) Return Loss over Temp

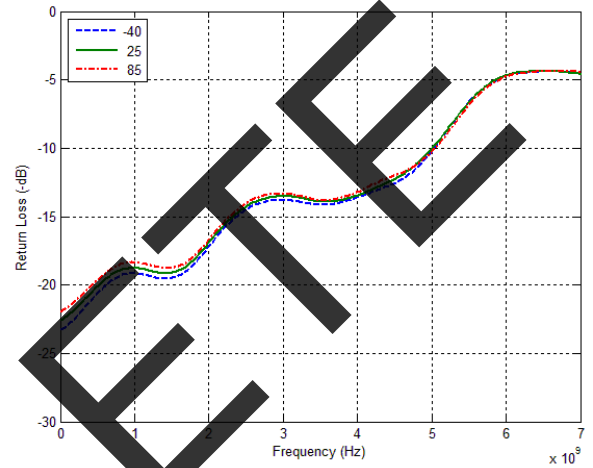

Figure 14. Opposite Channel (A to X) Isolation over V_{DD}

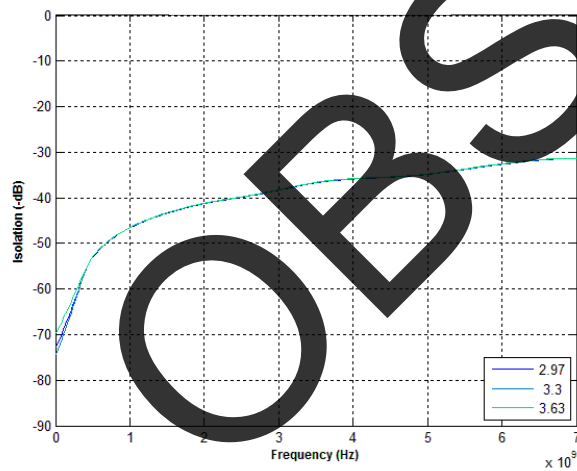
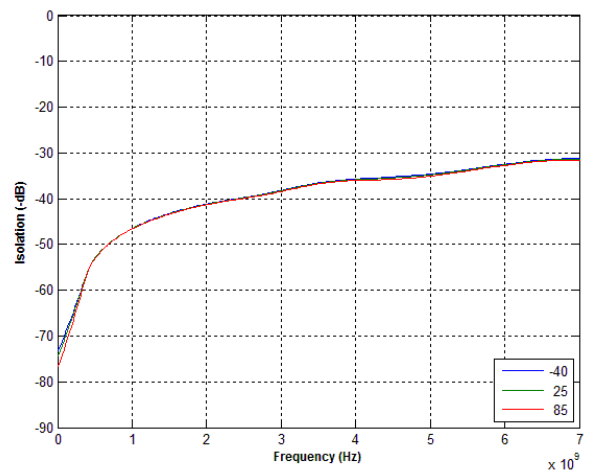

Figure 15. Opposite Channel (A to X) Isolation over Temp



Typical Performance Data @ 3.3V and +25 °C, unless otherwise specified (cont.)

Figure 16. Same Channel (A to B/C and X to Y/Z) Isolation over V_{DD}

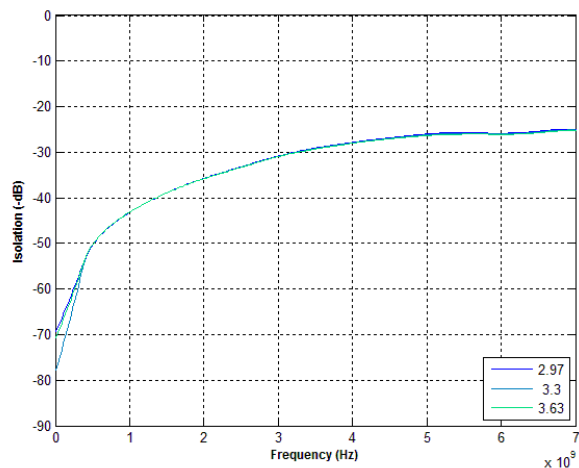

Figure 17. Same Channel (A to B/C and X to Y/Z) Isolation over Temp

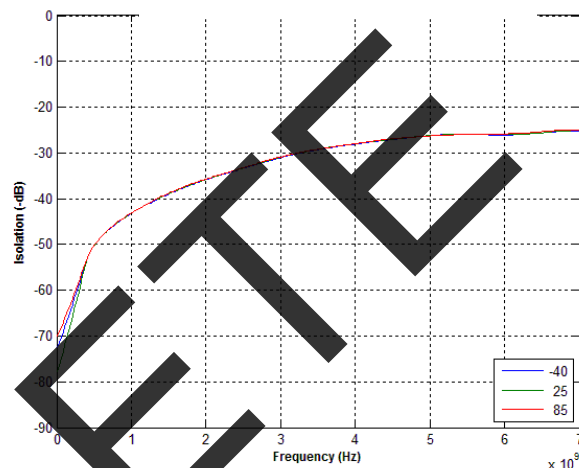

Figure 18. Switching Time (10/90% RF)

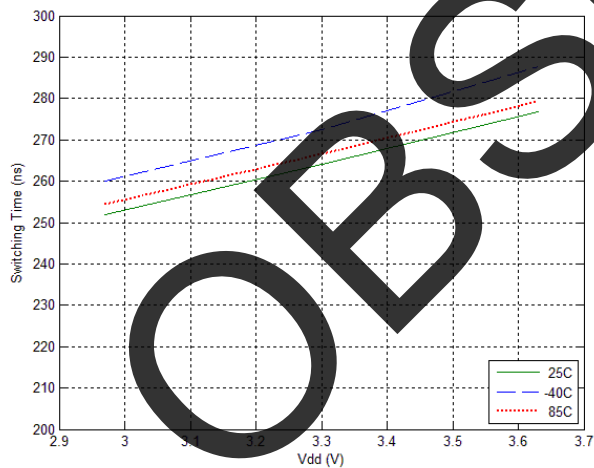

Figure 19. IIP3 (Single Ended)

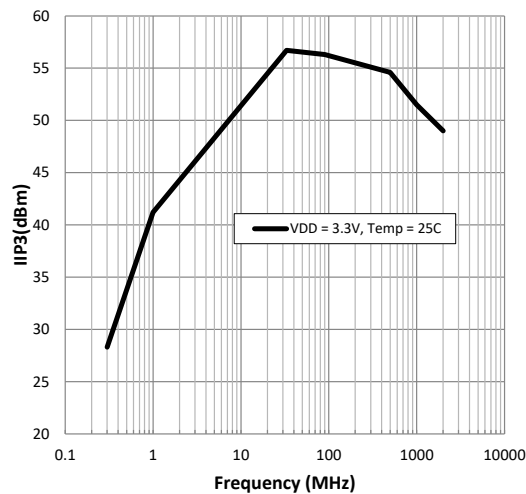

Figure 20. Phase Delta Matched Paths (6 GHz and +25 °C) Stability Across V_{DD}

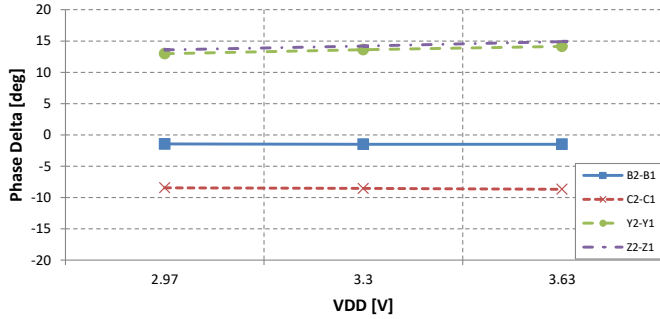

Figure 21. Phase Delta Matched Paths (6 GHz and 3.3V) Stability Across Temp

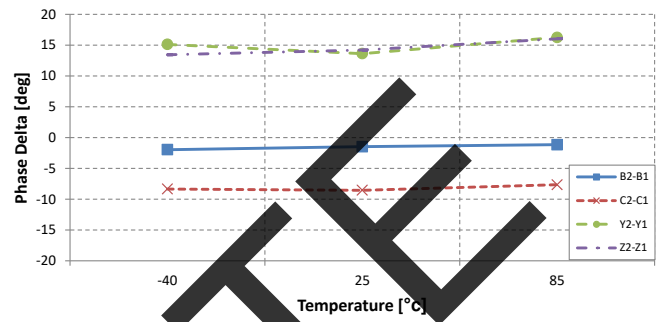

Figure 22. Phase Delta Un-matched Paths (6 GHz and +25 °C) Stability Across V_{DD}

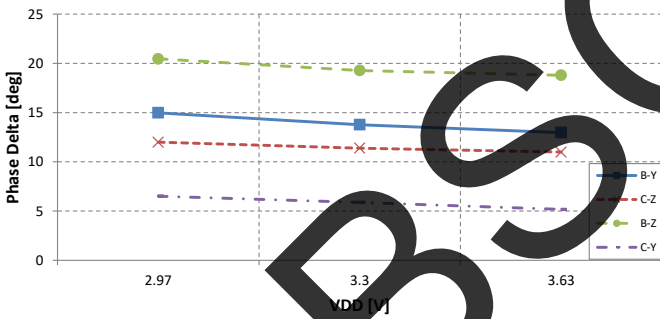
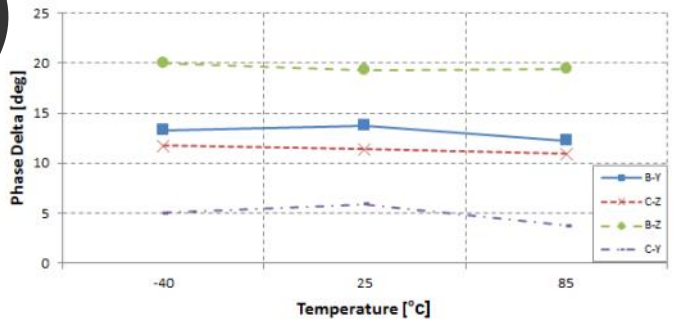

Figure 23. Phase Delta Un-matched Paths (6 GHz and 3.3V) Stability Across Temp



OBSOLETE

Evaluation board

The DDSPDT switch evaluation kit board was designed to ease customer evaluation of the PE42920 DDSPDT switch.

Calibration structures are available on the bottom side of the PCB. As an alternate connector option, a through transmission line connects connectors J14 and J13. This transmission line can be used to estimate the loss of the PCB over the environmental conditions being evaluated.

J20 provides a means for applying V_{DD} and controlling the logic of the device. A jumper can be used to set $AUX = V_{DD}$ or $AUX = GND$,* to toggle the logic state.

Proper PCB design is essential for full isolation performance. This evaluation board demonstrates good trace and ground management for minimum coupling and radiation.

DC blocking capacitors (external or on board) are required to prevent interaction with external test equipment. They can be used as external broadband DC blocks or replace 0Ω resistors on board with the desired capacitance value on operation frequency.

Note: * Silkscreen Error – AUX and V_{SEL} labels are swapped. AUX jumper pin on J20 header is equivalent to the V_{SEL} control in the block diagram. V_{SEL} jumper pin on J20 header is a no connect.

Figure 24. Evaluation Board Layouts

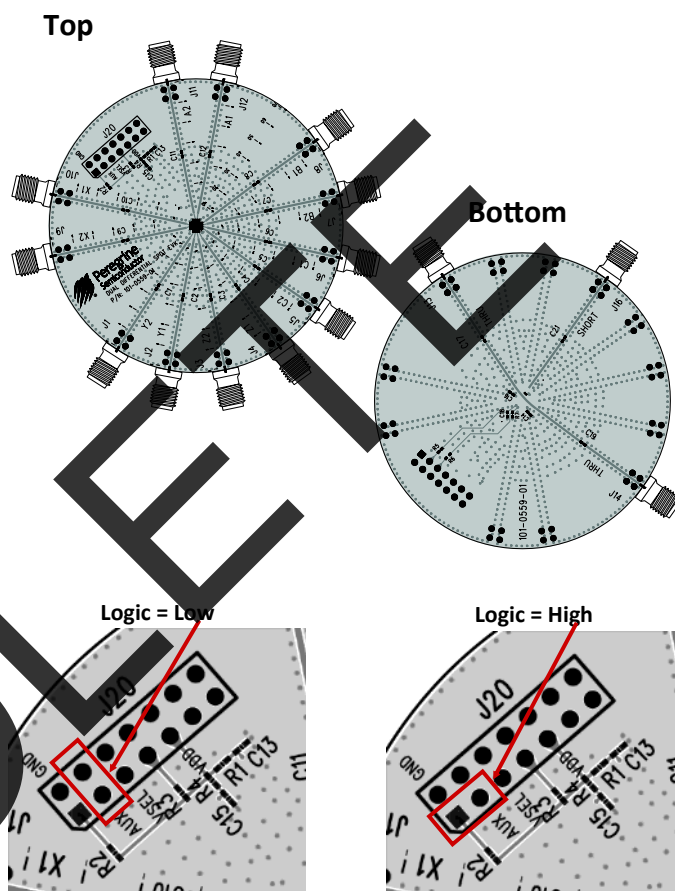

PRT-09905

Figure 25. Evaluation Board Schematic^{1,2,3}

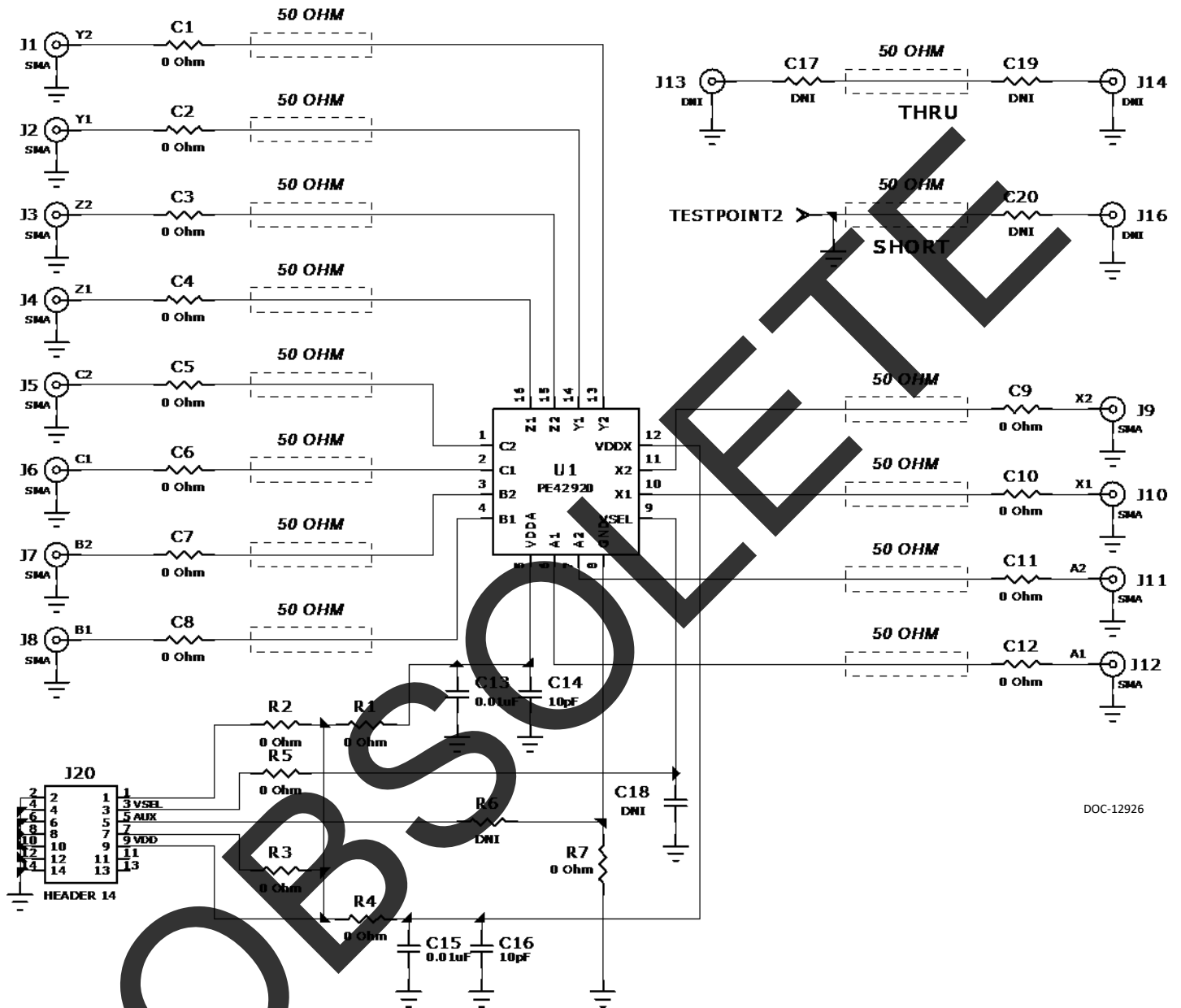

DOC-12926

- Notes:
1. CAUTION: Contains parts and assemblies susceptible to damage by electrostatic discharge (ESD).
 2. Silkscreen error: AUX and VSEL labels are swapped on PCB at J20 location.
 3. Pin 8 is grounded in PE42920.

Figure 26. Package Drawing
16-lead 3 × 3 mm QFN

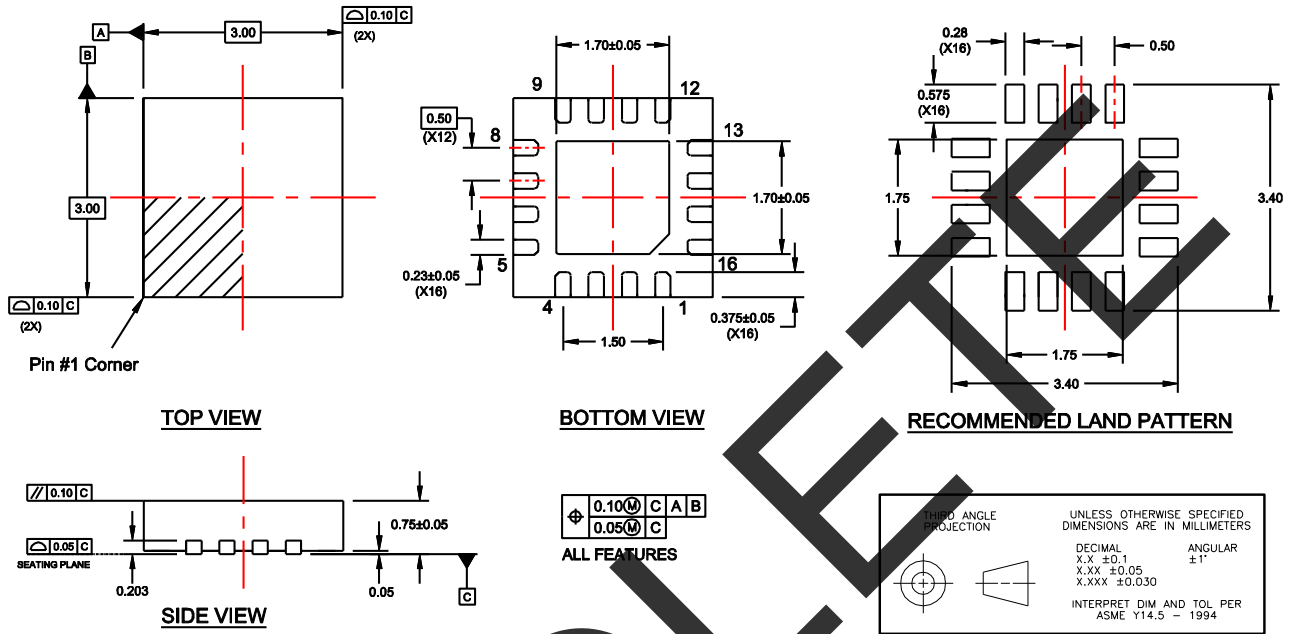

DOC-01881

Figure 27. Top Marking Specification



- = Pin 1 indicator
- YY = Last two digits of assembly year
- WW = Assembly work week
- ZZZZZ = Assembly lot code (maximum five characters)

DOC-66062

Figure 28. Tape and Reel Specifications
16-lead 3x3 mm QFN

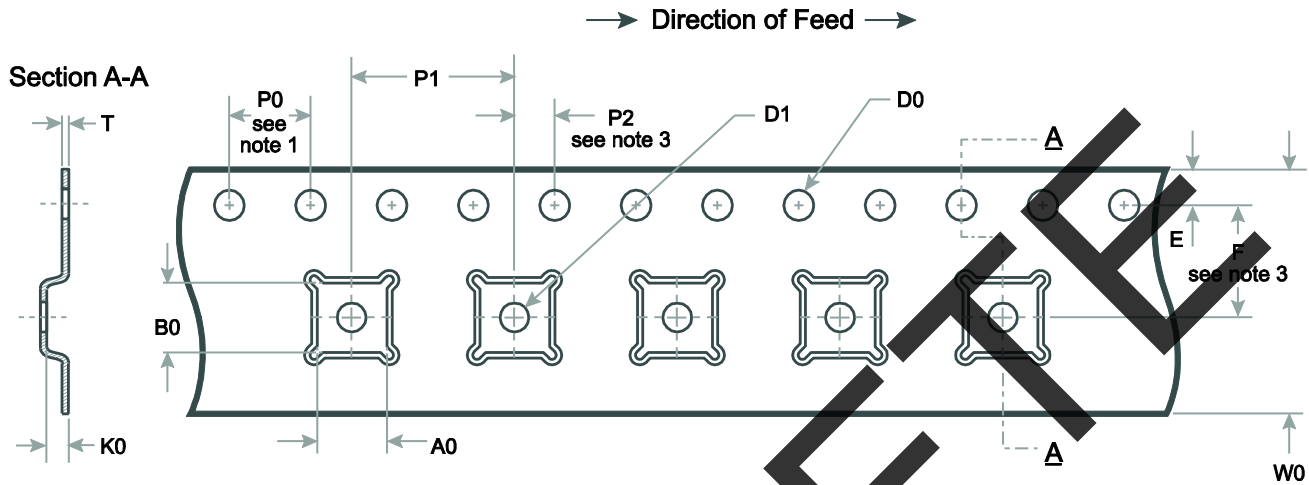

Notes:

1. 10 Sprocket hole pitch cumulative tolerance ± 0.2
2. Camber in compliance with EIA 481
3. Pocket position relative to sprocket hole measured as true position of pocket, not pocket hole

A0	3.30
B0	3.30
K0	1.10
D0	$1.50 + 0.1/-0.0$
D1	1.5 min
E	1.75 ± 0.10
F	5.50 ± 0.05
P0	4.00
P1	8.00
P2	2.00 ± 0.05
T	0.30 ± 0.05
W0	12.00 ± 0.3

THIRD ANGLE PROJECTION

UNLESS OTHERWISE SPECIFIED DIMENSIONS ARE IN MILLIMETERS

DECIMAL	ANGULAR
X.X ± 0.1	$\pm 1^\circ$
X.XX ± 0.05	
X.XXX ± 0.030	

INTERPRET DIM AND TOL PER ASME Y14.5 - 1994

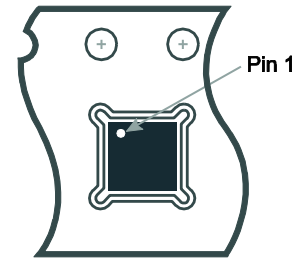

Device Orientation in Tape

Table 6. Ordering Information

Order Code	Description	Package	Shipping Method
PE42920MLAA-Z	PE42920 DDSPDT RF Switch	Green 16-lead 3 x 3 mm QFN	3000 units T/R
EK42920-01	PE42920 Evaluation Board	Evaluation Kit	1/box

Sales Contact and Information

For sales and contact information please visit www.psemi.com.

Advance Information: The product is in a formative or design stage. The datasheet contains design target specifications for product development. Specifications and features may change in any manner without notice. **Preliminary Specification:** The datasheet contains preliminary data. Additional data may be added at a later date. Peregrine reserves the right to change specifications at any time without notice in order to supply the best possible product. **Product Specification:** The datasheet contains final data. In the event Peregrine decides to change the specifications, Peregrine will notify customers of the intended changes by issuing a CNF (Customer Notification Form). The information in this datasheet is believed to be reliable. However, Peregrine assumes no liability for the use of this information. Use shall be entirely at the user's own risk. No patent rights or licenses to any circuits described in this datasheet are implied or granted to any third party.

Peregrine's products are not designed or intended for use in devices or systems intended for surgical implant, or in other applications intended to support or sustain life, or in any application in which the failure of the Peregrine product could create a situation in which personal injury or death might occur. Peregrine assumes no liability for damages, including consequential or incidental damages, arising out of the use of its products in such applications. The Peregrine name, logo, UltraCMOS and UTISI are registered trademarks and HaRP, MultiSwitch and DuNE are trademarks of Peregrine Semiconductor Corp. Peregrine products are protected under one or more of the following U.S. Patents: <http://patents.psemi.com>.