

PE4134

High Linearity Quad MOSFET Mixer for PCS & 3G BTS

Features

- Integrated, single-ended RF & LO interfaces
- High linearity: IIP3 >+31 dBm, 1.9 GHz (+17 dBm LO)
- Low-conversion loss: 7.4 dB (+17 dBm LO)
- High isolation: Typical LO-IF at 33 dB, LO-RF at 31 dB
- Optimized for low-side LO injection
- Packaged in a 6-lead 3x3 mm DFN

Product Description

The PE4134 is a high linearity, passive Quad MOSFET Mixer for PCS & 3G Base Station Receivers, exhibiting high dynamic range performance over a broad LO drive range of up to +20 dBm. This mixer integrates passive matching networks to provide single-ended interfaces for the RF and LO ports, eliminating the need for external RF baluns or matching networks. The PE4134 is optimized for frequency down-conversion using low-side LO injection for PCS & 3G Base Station applications, and is also suitable for up-conversion applications.

The PE4134 is manufactured on Peregrine's UltraCMOS™ process, a patented variation of silicon-on-insulator (SOI) technology on a sapphire substrate, offering the performance of GaAs with the economy and integration of conventional CMOS.

Figure 1. Functional Diagram

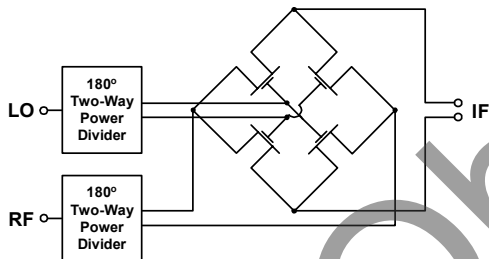

Figure 2. Package Type

6-lead 3x3 mm DFN



Table 1. AC and DC Electrical Specifications @ +25 °C

Parameter	Minimum	Typical	Maximum	Units
Frequency Range:				
LO	1540	--	1740	MHz
RF	1800	--	2000	MHz
IF ¹	--	260	--	MHz
Conversion Loss ²		7.4	8.0	dB
Isolation:				
LO-RF	27	31		dB
LO-IF	27	33		dB
Input IP3				
1.8 GHz	26	29		dBm
1.9 GHz	31	33		dBm
2.0 GHz	28	31		dBm
Input 1 dB Compression		22		dBm

Notes: 1. An IF frequency of 260 MHz is a nominal frequency. The IF frequency can be specified by the user as long as the RF and LO frequencies are within the specified maximum and minimum.

2. Conversion Loss includes loss of IF transformer (M/A COM ETK4-2T, nominal loss 0.7 dB at 260 MHz).

*Test conditions unless otherwise noted: IF = 260 MHz, LO input drive = 17 dBm, RF input drive = 3 dBm.

Figure 3. Pin Configuration (Top View)

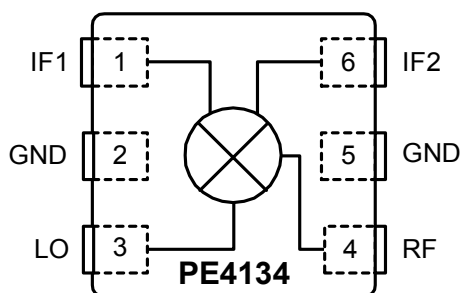

Table 2. Pin Descriptions

Pin No.	Pin Name	Description
1	IF1	IF differential output
2	GND	Ground connections for Mixer. Traces should be physically short and connect immediately to ground plane for best performance. The exposed solder pad must also be soldered to the ground plane for best performance.
3	LO	LO Input
4	RF	RF Input
5	GND	Ground connections for Mixer. Traces should be physically short and connect immediately to ground plane for best performance. The exposed solder pad must also be soldered to the ground plane for best performance.
6	IF2	IF differential output

Table 3. Absolute Maximum Ratings

Symbol	Parameter/Conditions	Min	Max	Units
T_{ST}	Storage temperature range	-65	150	°C
T_{OP}	Operating temperature range	-40	85	°C
P_{LO}	LO input power		20	dBm
P_{RF}	RF input power		12	dBm
V_{ESD}	ESD Sensitive Device		250	V

Absolute Maximum Ratings are those values listed in the above table. Exceeding these values may cause permanent device damage. Functional operation should be restricted to the limits in the DC Electrical Specifications table. Exposure to absolute maximum ratings for extended periods may affect device reliability.

Electrostatic Discharge (ESD) Precautions

When handling this UltraCMOS™ device, observe the same precautions that you would use with other ESD-sensitive devices. Although this device contains circuitry to protect it from damage due to ESD, precautions should be taken to avoid exceeding the rating specified.

Latch-Up Avoidance

Unlike conventional CMOS devices, UltraCMOS™ devices are immune to latch-up.

Evaluation Kit

Figure 4. Evaluation Board Layout

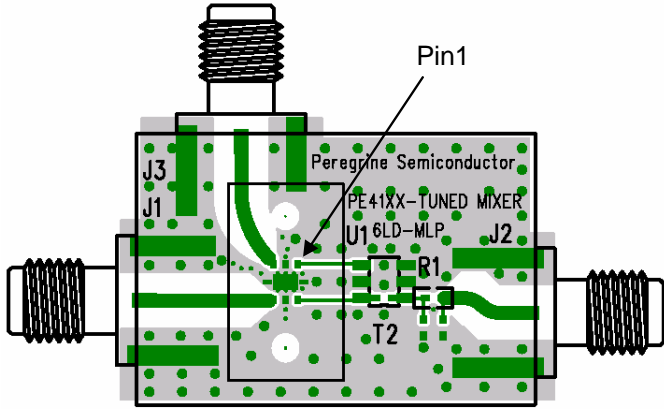

Table 4. Bill of Materials

Reference	Value / Description
T2	M/A Com ETK4-2T
R1	0 Ω
U1	PE4134 MLP Mixer
J1, J2, J3	SMA Connector

Applications Support

If you have a problem with your evaluation kit or if you have applications questions, please contact applications support:

E-Mail: help@psemi.com (fastest response)
Phone: (858) 731-9400

Figure 5. Evaluation Board Schematic Diagram

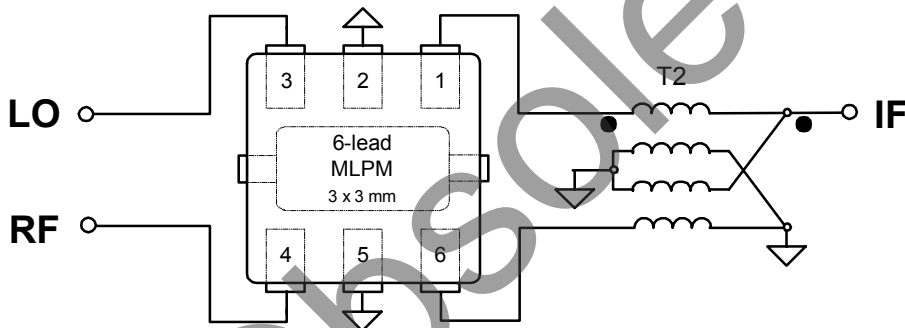

T2, M/A-Com E-Series RF 4:1 Transformer, 2.0 – 1000 MHz, ETK4-2T

Figure 6. Evaluation Board Testing Block Diagram, 2-Tone Setup

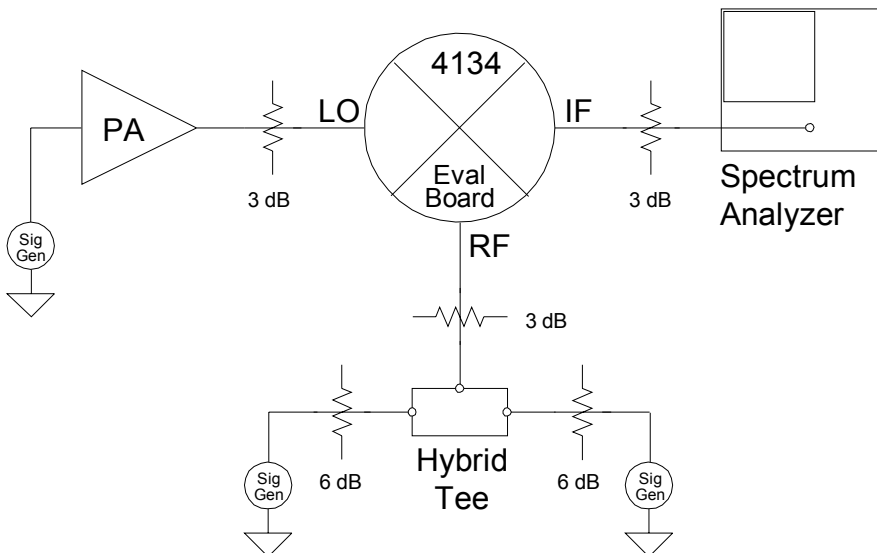

Typical Performance Data (LO=17 dBm, RF=3 dBm, IF=260 MHz)

Figure 7. Conversion Loss

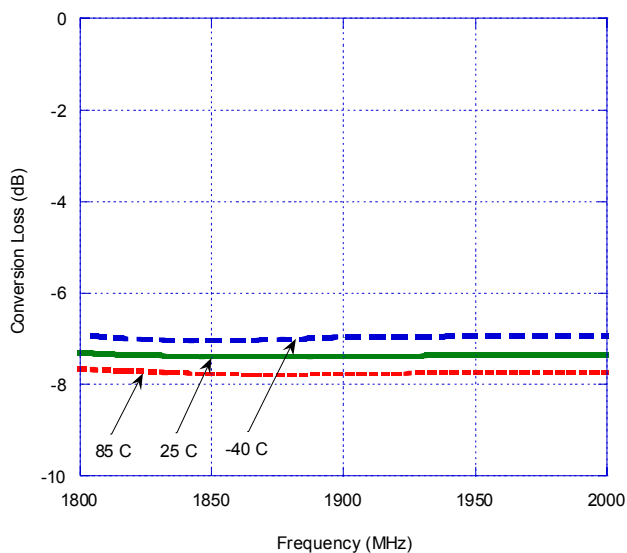

Figure 8. Input 1dB Compression

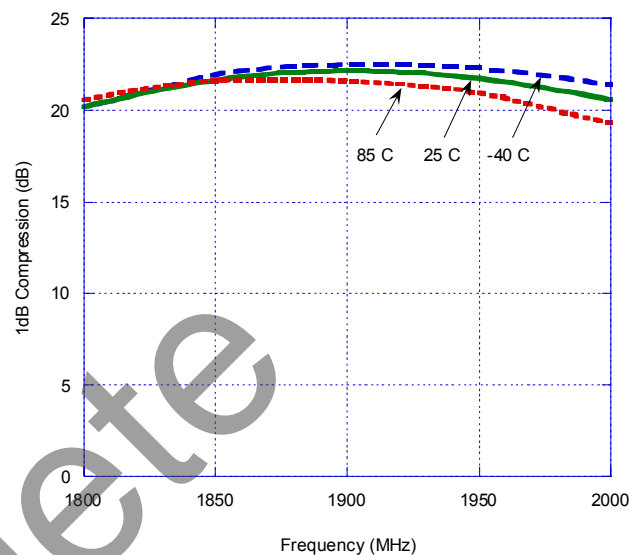

Figure 9. Input IP3

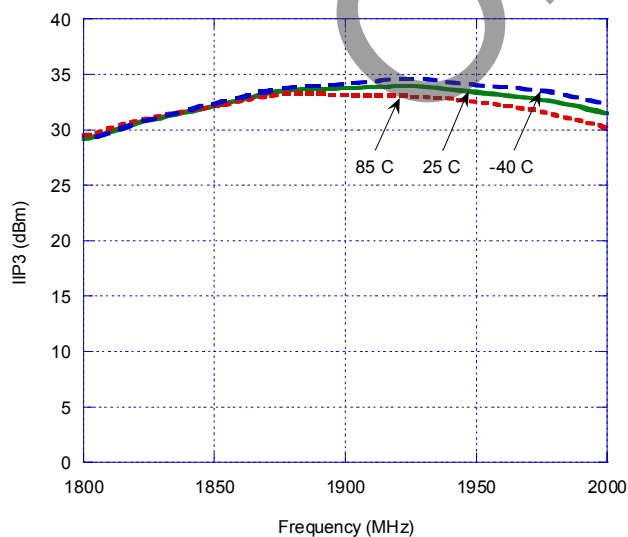
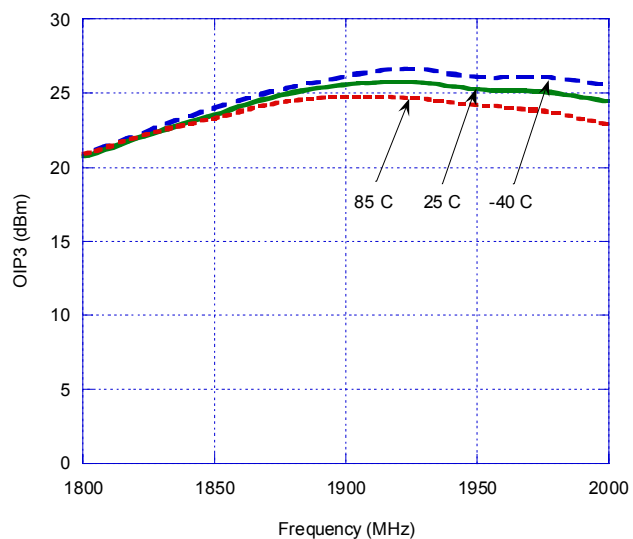

Figure 10. Output IP3



Typical Performance Data (LO=17 dBm, RF=3 dBm, IF=260 MHz)

Figure 11. LO-IF Isolation vs. Frequency

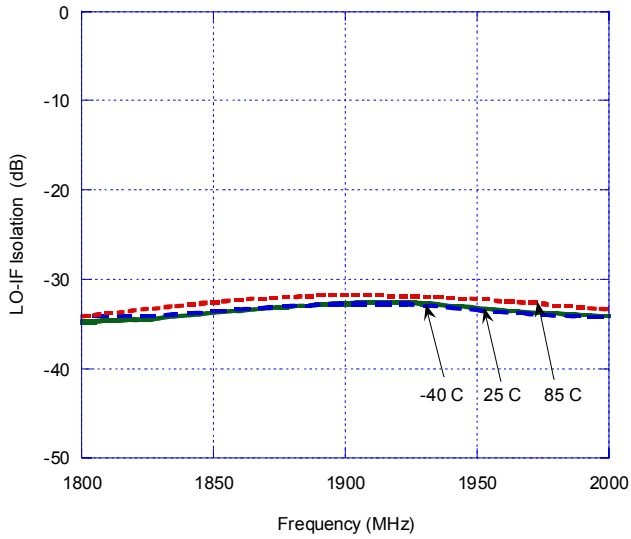

Figure 12. LO-RF Isolation vs. Frequency

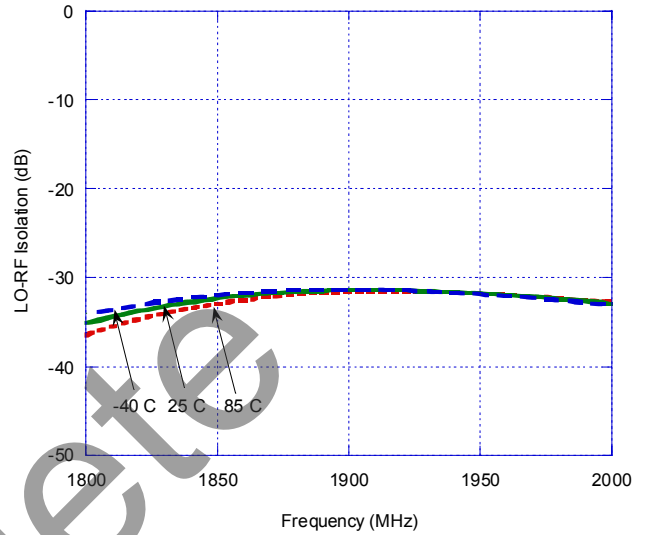

Figure 13. LO Port Return Loss @ 25°C

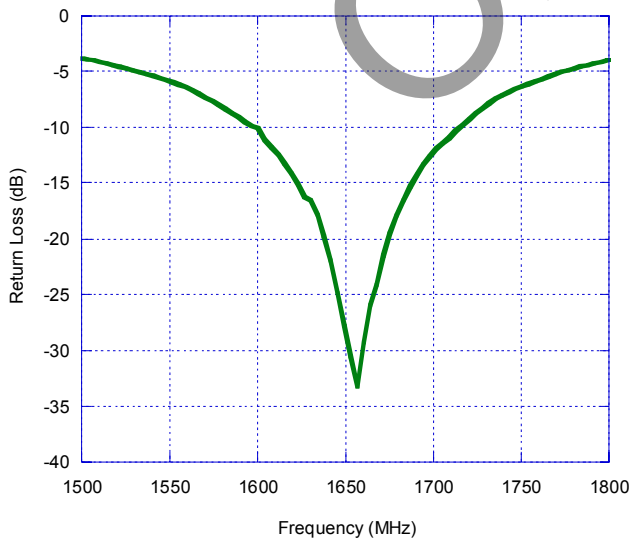
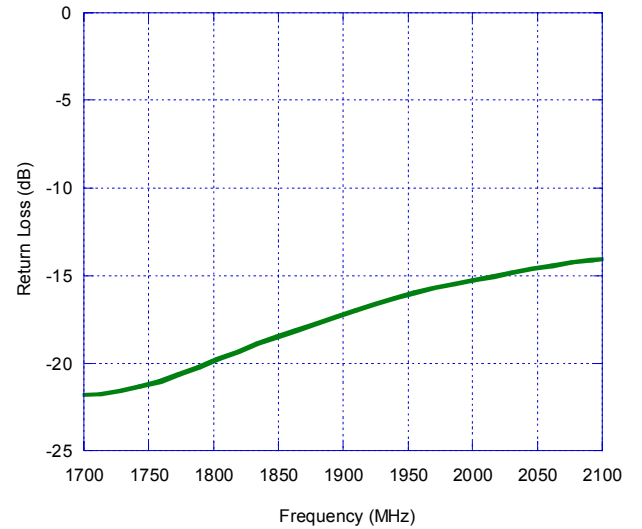

Figure 14. RF Port Return Loss @ 25°C



Typical Performance Data @ +25 °C (RF=3 dBm, IF=260 MHz)

Figure 15. Conversion Loss across LO Power

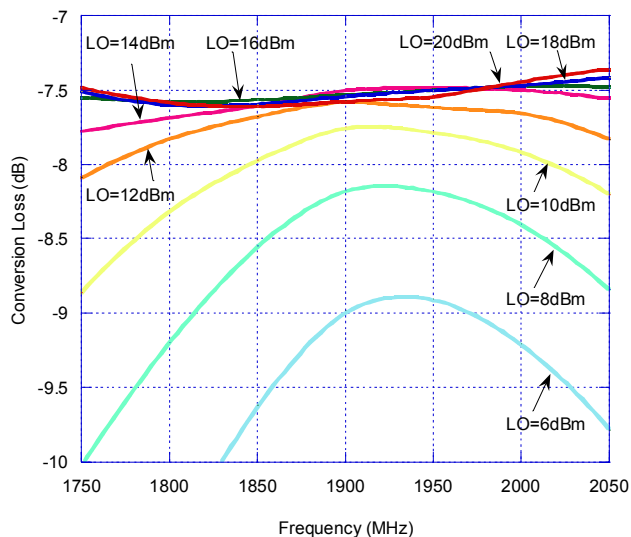

Figure 16. Input IP3 across LO Power

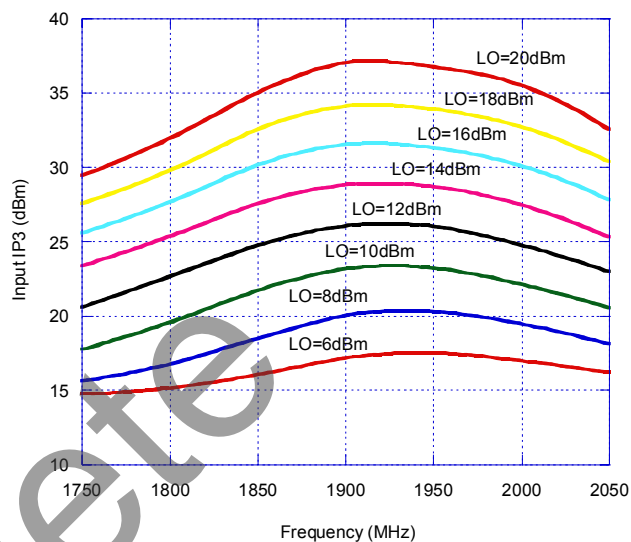

Table 5. Spurious Response

Spurious Response				
mRF	mRF+nLO			
	nLO			
	1	2	3	4
1	5	37	30	50
2	49	55	65	59
3	75	>85	78	80
4	>85	84	>85	>85

Normalized to dB below PIF

(RF=1900 Mhz @ 3 dBm, LO=1640 MHz @ 17 dBm)

Table 6. Spurious Response

Spurious Response				
mRF	mRF+nLO			
	nLO			
	1	2	3	4
1	0	32	22	43
2	57	49	61	62
3	64	71	64	65
4	>85	>85	>85	81

Normalized to dB below PIF

(RF=1900 Mhz @ 3 dBm, LO=1640 MHz @ 17 dBm)

Figure 17. Package Drawing

6-lead DFN

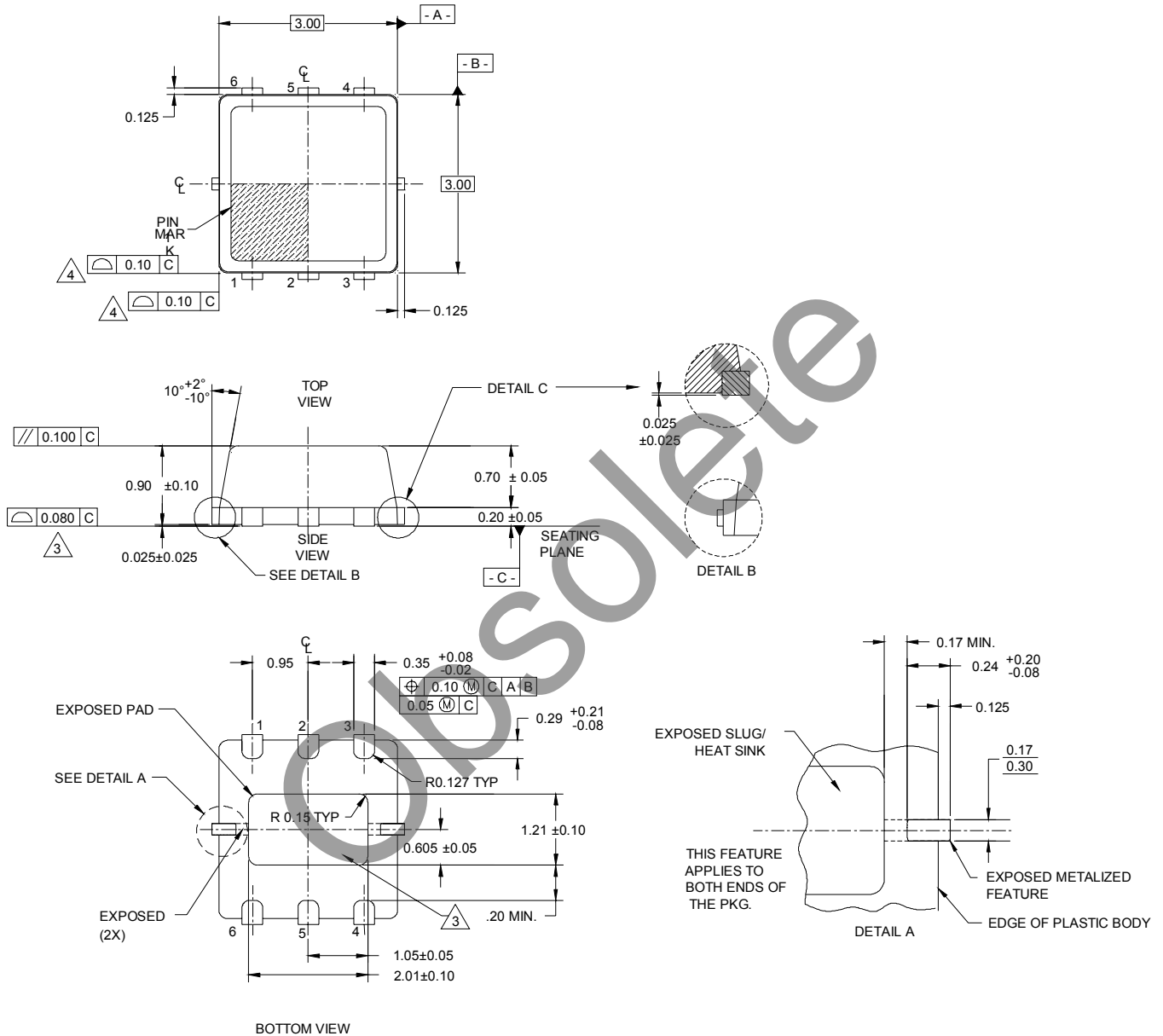

1. DIMENSIONS AND TOLERANCES ARE PER ANSI Y14.5
2. DIMENSIONS ARE IN MILLIMETERS, ANGLES ARE IN DEGREES.
3. COPLANARITY APPLIES TO EXPOSED HEAT SLUG AS WELL AS THE TERMINALS.
4. PROFILE TOLERANCE APPLIES TO PLASTIC BODY ONLY.

Figure 18. Tape and Reel Specifications

6-lead DFN

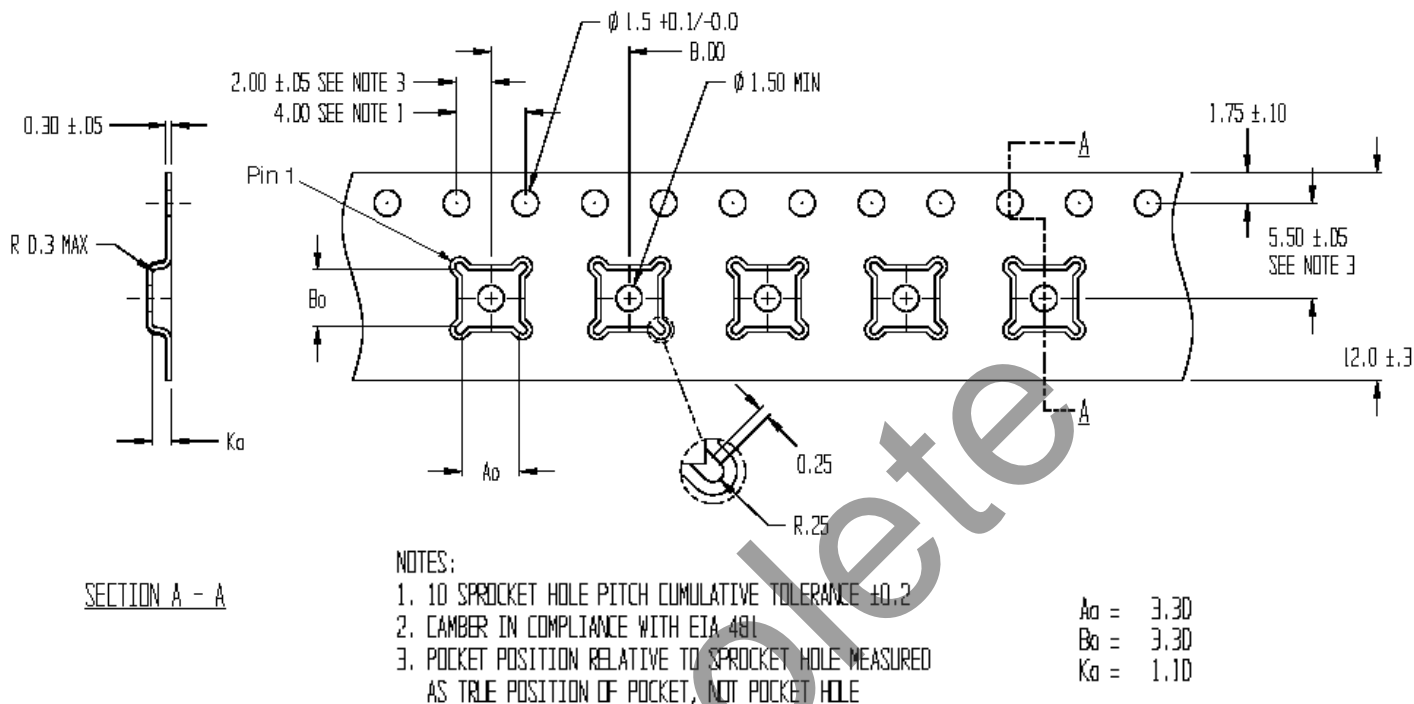

Table 7. Dimensions

Dimension	DFN 3x3 mm
A_o	3.23 ± 0.1
B_o	3.17 ± 0.1
K_o	1.37 ± 0.1
P	4 ± 0.1
W	$8 +0.3, -0.1$
T	0.254 ± 0.02
R7 Quantity	3000
R13 Quantity	N.A.

Note: R7 = 7 inch Lock Reel, R13 = 13 inch Lock Reel

Table 8. Ordering Information

Order Code	Part Marking	Description	Package	Shipping Method
4134-01	4134	PE4134-06DFN3x3-12800F	6-lead 3x3 mm DFN	12800 units / Canister
4134-02	4134	PE4134-06DFN3x3-3000C	6-lead 3x3 mm DFN	3000 units / T&R
4134-00	4134-EK	PE4134-06DFN3x3-EK	Evaluation Board	1 / Box

Sales Offices

The Americas

Peregrine Semiconductor Corporation

9450 Carroll Park Drive
San Diego, CA 92121
Tel 858-731-9400
Fax 858-731-9499

Europe

Peregrine Semiconductor Europe

Bâtiment Maine
13-15 rue des Quatre Vents
F- 92380 Garches, France
Tel: +33-1-47-41-91-73
Fax : +33-1-47-41-91-73

Space and Defense Products

Americas:

Tel: 505-881-0438
Fax: 505-881-0443

Europe, Asia Pacific:

180 Rue Jean de Guiramand
13852 Aix-En-Provence cedex 3, France
Tel: +33(0) 4 4239 3361
Fax: +33(0) 4 4239 7227

For a list of representatives in your area, please refer to our Web site at: www.psemi.com

Data Sheet Identification

Advance Information

The product is in a formative or design stage. The data sheet contains design target specifications for product development. Specifications and features may change in any manner without notice.

Preliminary Specification

The data sheet contains preliminary data. Additional data may be added at a later date. Peregrine reserves the right to change specifications at any time without notice in order to supply the best possible product.

Product Specification

The data sheet contains final data. In the event Peregrine decides to change the specifications, Peregrine will notify customers of the intended changes by issuing a DCN (Document Change Notice).

North Asia Pacific

Peregrine Semiconductor K.K.

5A-5, 5F Imperial Tower
1-1-1 Uchisaiwaicho, Chiyoda-ku
Tokyo 100-0011 Japan
Tel: +81-3-3502-5211
Fax: +81-3-3502-5213

Peregrine Semiconductor, Korea

#B-2402, Kolon Tripolis, #210
Geumgok-dong, Bundang-gu, Seongnam-si
Gyeonggi-do, 463-480 S. Korea
Tel: +82-31-728-4300
Fax: +82-31-728-4305

South Asia Pacific

Peregrine Semiconductor, China

Shanghai, 200040, P.R. China
Tel: +86-21-5836-8276
Fax: +86-21-5836-7652

The information in this data sheet is believed to be reliable. However, Peregrine assumes no liability for the use of this information. Use shall be entirely at the user's own risk.

No patent rights or licenses to any circuits described in this data sheet are implied or granted to any third party.

Peregrine's products are not designed or intended for use in devices or systems intended for surgical implant, or in other applications intended to support or sustain life, or in any application in which the failure of the Peregrine product could create a situation in which personal injury or death might occur. Peregrine assumes no liability for damages, including consequential or incidental damages, arising out of the use of its products in such applications.

The Peregrine name, logo, and UTSi are registered trademarks and UltraCMOS and HaRP are trademarks of Peregrine Semiconductor Corp.