

**UltraCMOS® Integer-N PLL Frequency Synthesizer for Low Phase Noise Applications**

**Product Description**

Peregrine's PE33241 is a high-performance Integer-N PLL capable of frequency synthesis up to 5 GHz. This device is designed for use in industrial and military applications, point-to-point radios, wireless infrastructure and CATV equipment.

The PE33241 offers superior phase noise performance with a direct or serial programming option. It features a selectable prescaler modulus of 5/6 or 10/11, counters and a phase comparator as shown in *Figure 1*. Counter values are programmable through either a serial interface or directly hard-wired.

The PE33241 is available in a 48-lead 7x7 mm QFN and is manufactured on Peregrine's UltraCMOS® process, a patented variation of silicon-on-insulator (SOI) technology on a sapphire substrate, offering excellent RF performance.

**Features**

- Frequency range
  - 5 GHz in 10/11 prescaler modulus
  - 4 GHz in 5/6 prescaler modulus
- Phase noise floor figure of merit: -230 dBc/Hz
- Low power: 75 mA typ @ 2.8V
- Selectable prescaler modulus of 5/6 or 10/11
- Serial or direct mode access
- Internal phase detector
- Packaged in a 48-lead 7x7 mm QFN

**Figure 1. Functional Diagram**

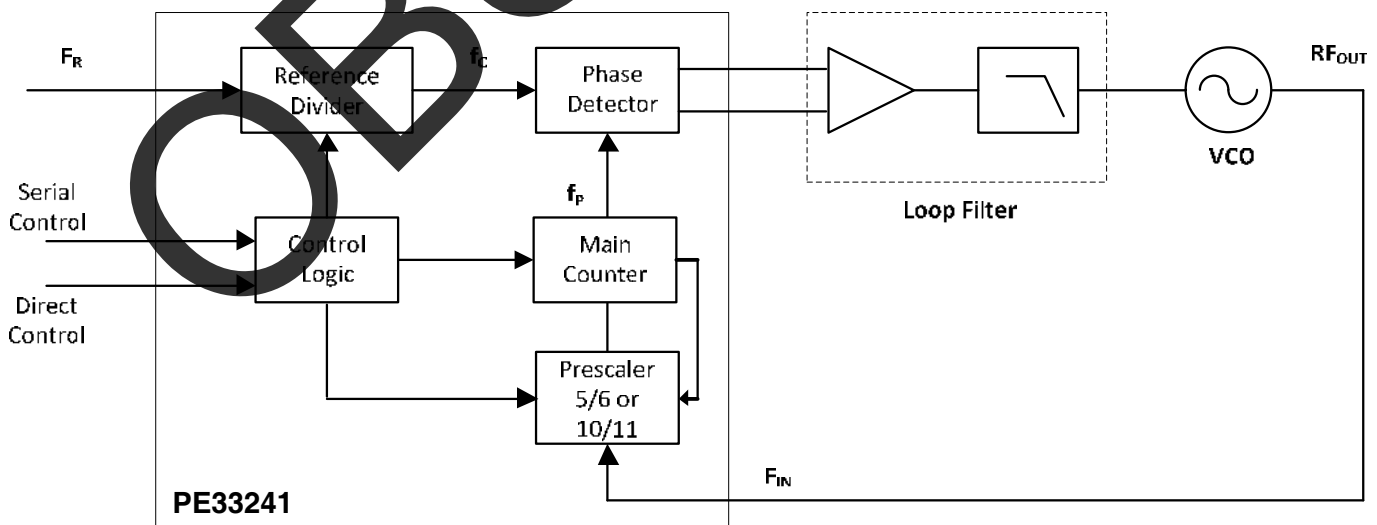


Figure 2. Pin Configurations (Top View)

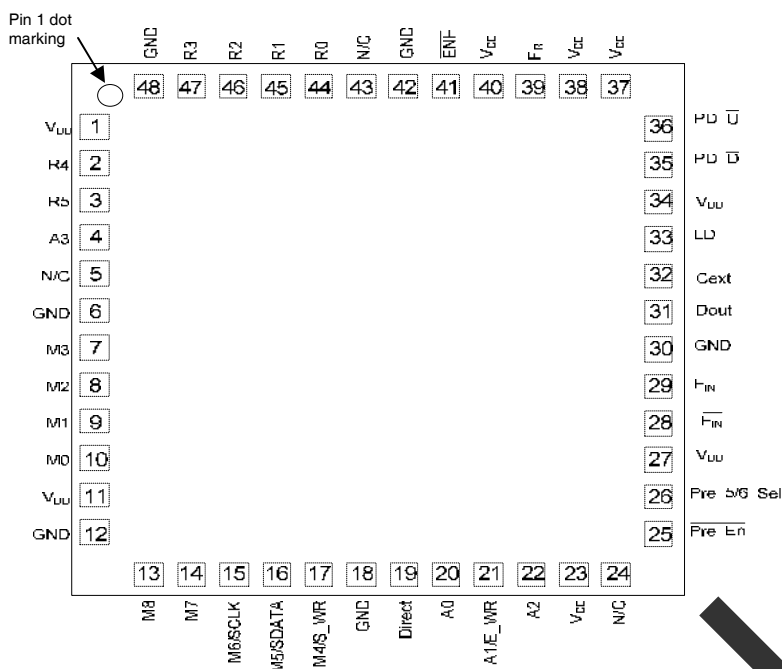


Figure 3. Package Type  
48-lead 7x7 mm QFN



Table 1. Pin Descriptions

Pin #	Pin Name	Interface Mode	Type	Description
1	V <sub>DD</sub>	Both	Note 1	Power supply input. Input may range from 2.65V to 2.95V. Bypassing recommended
2	R4	Direct	Input	R counter bit 4
3	R5	Direct	Input	R counter bit 5
4	A3	Direct	Input	A counter bit 3
5	N/C	Both	Note 3	No connect
6	GND	Both		Ground
7	M3	Direct	Input	M counter bit 3
8	M2	Direct	Input	M counter bit 2
9	M1	Direct	Input	M counter bit 1
10	M0	Direct	Input	M counter bit 0
11	V <sub>DD</sub>	Both	Note 1	Power supply input. Input may range from 2.65V to 2.95V. Bypassing recommended
12	GND	Both		Ground
13	M8	Direct	Input	M counter bit 8
14	M7	Direct	Input	M counter bit 7
15	SCLK	Serial	Input	Serial clock input. SDATA is clocked serially into the 20-bit primary register (E_WR "low") or the 8-bit enhancement register (E_WR "high") on the rising edge of SCLK
	M6	Direct	Input	M counter bit 6
16	SDATA	Serial	Input	Binary serial data input. Input data entered MSB first
	M5	Direct	Input	M counter bit 5
17	S_WR	Serial	Input	Serial load enable input. While S_WR is "low", SDATA can be serially clocked. Primary register data is transferred to the secondary register on S_WR rising edge
	M4	Direct	Input	M counter bit 4

**Table 1. Pin Descriptions (continued)**

Pin #	Pin Name	Interface Mode	Type	Description
18	GND	Both		Ground
19	Direct	Direct	Input	Select "high" enables Direct Mode. Select "low" enables Serial Mode
20	A0	Direct	Input	A counter bit 0
21	E_WR	Serial	Input	Enhancement register write enable. While E_WR is "high" SDATA can be serially clocked into the enhancement register on the rising edge of SCLK
	A1	Direct	Input	A counter bit 1
22	A2	Direct	Input	A counter bit 2
23	V <sub>DD</sub>	Both	Note 1	Power supply input. Input may range from 2.65V to 2.95V. Bypassing recommended
24	N/C	Both	Note 3	No connect
25	Pre_En	Direct	Input	Prescaler enable, active "low". When "high", F <sub>IN</sub> bypasses the prescaler
26	Pre_5/6_Sel	Direct	Input	5/6 modulus select, active "high." When "low," 10/11 modulus selected
27	V <sub>DD</sub>	Both	Note 1	Power supply input. Input may range from 2.65V to 2.95V. Bypassing recommended
28	F <sub>IN</sub>	Both	Input	Prescaler complementary input. A 22 pF bypass capacitor should be placed as close as possible to this pin and be connected in series with a 50Ω resistor to ground
29	F <sub>IN</sub>	Both	Input	Prescaler input from the VCO, 5 GHz max frequency. A 22 pF coupling capacitor should be placed as close as possible to this pin and be connected in shunt to a 50Ω resistor to ground
30	GND	Both		Ground
31	Dout	Serial	Output	Data Out. The MSEL signal and the raw prescaler output are available on Dout through enhancement register programming
32	Cext	Both	Output	Logical "NAND" of PD <sub>D</sub> and PD <sub>U</sub> terminated through an on chip 2 kΩ series resistor. Connecting Cext to an external capacitor will low pass filter the input to the inverting amplifier used for driving LD
33	LD	Both	Output	Lock detect and open drain logical inversion of Cext. When the loop is in lock, LD is high impedance, otherwise LD is a logic low ("0")
34	V <sub>DD</sub>	Both	Note 1	Power supply input. Input may range from 2.65V to 2.95V. Bypassing recommended
35	PD <sub>D</sub>	Both	Output	PD <sub>D</sub> is pulse down when f <sub>p</sub> leads f <sub>c</sub>
36	PD <sub>U</sub>	Both	Output	PD <sub>U</sub> is pulse down when f <sub>c</sub> leads f <sub>p</sub>
37	V <sub>DD</sub>	Both	Note 1	Power supply input. Input may range from 2.65V to 2.95V. Bypassing recommended
38	V <sub>DD</sub>	Both	Note 1	Power supply input. Input may range from 2.65V to 2.95V. Bypassing recommended
39	F <sub>R</sub>	Both	Input	Reference frequency input
40	V <sub>DD</sub>	Both	Note 1	Power supply input. Input may range from 2.65V to 2.95V. Bypassing recommended
41	ENH	Serial	Input	Enhancement mode. When asserted low ("0"), enhancement register bits are functional
42	GND	Both		Ground
43	N/C	Both	Note 3	No connect
44	R0	Direct	Input	R counter bit 0
45	R1	Direct	Input	R counter bit 1
46	R2	Direct	Input	R counter bit 2
47	R3	Direct	Input	R counter bit 3
48	GND	Both		Ground

- Notes: 1. V<sub>DD</sub> pins 1, 11, 23, 27, 34, 37, 38 and 40 are connected by diodes and must be supplied with the same positive voltage level  
2. All digital input pins have 70 kΩ pull-down resistors to ground  
3. No connect pins can be left open or floating

**Table 2. Operating Ranges**

Parameter/Condition	Symbol	Min	Typ	Max	Unit
Supply voltage	$V_{DD}$	2.65	2.8	2.95	V
RF input power, CW 50 MHz – 5 GHz	$P_{MAX,CW}$			10	dBm
Operating ambient temperature range	$T_A$	-40	+25	+85	°C

**Table 3. Absolute Maximum Ratings**

Parameter/Condition	Symbol	Min	Max	Unit
Supply voltage	$V_{DD}$	-0.3	3.3	V
Voltage on any input	$V_I$	-0.3	$V_{DD} + 0.3$	V
DC into any input	$I_I$	-10	+10	mA
DC into any output	$I_O$	-10	+10	mA
Storage temperature range	$T_{ST}$	-65	+150	°C
ESD voltage HBM <sup>1</sup> All pins except pin 31	$V_{ESD,HBM}$		1000	V
ESD voltage HBM <sup>1,2</sup> On pin 31			300	V

Notes: 1. Human Body Model (MIL-STD 883 Method 3015)  
2. Pin 31 is not used in normal operation

Exceeding absolute maximum ratings may cause permanent damage. Operation should be restricted to the limits in the Operating Ranges table. Operation between operating range maximum and absolute maximum for extended periods may reduce reliability.

### Electrostatic Discharge (ESD) Precautions

When handling this UltraCMOS<sup>®</sup> device, observe the same precautions that you would use with other ESD-sensitive devices. Although this device contains circuitry to protect it from damage due to ESD, precautions should be taken to avoid exceeding the rating specified.

### Latch-Up Avoidance

Unlike conventional CMOS devices, UltraCMOS<sup>®</sup> devices are immune to latch-up.

### Moisture Sensitivity Level

The Moisture Sensitivity Level rating for the PE33241 in the 48-lead 7x7 mm QFN package is MSL3.

**Table 4. DC Characteristics @ 25°C, V<sub>DD</sub> = 2.8V, unless otherwise noted**

Symbol	Parameter	Condition	Min	Typ	Max	Unit
I <sub>DD</sub>	Operational supply current	Prescaler disabled, f <sub>c</sub> = 50 MHz, F <sub>IN</sub> = 500 MHz		40	50	mA
		5/6 prescaler, f <sub>c</sub> = 50 MHz, F <sub>IN</sub> = 3 GHz		75	100	mA
		10/11 prescaler, f <sub>c</sub> = 50 MHz, F <sub>IN</sub> = 3 GHz		76	100	mA
Digital Inputs: All except F <sub>R</sub> , F <sub>IN</sub> , F <sub>IN</sub> <sup>̄</sup>						
V <sub>IH</sub>	High level input voltage		0.7 x V <sub>DD</sub>			V
V <sub>IL</sub>	Low level input voltage				0.3 x V <sub>DD</sub>	V
I <sub>IH</sub>	High level input current	V <sub>IH</sub> = V <sub>DD</sub> = 2.95V			70	μA
I <sub>IL</sub>	Low level input current	V <sub>IL</sub> = 0, V <sub>DD</sub> = 2.95V	-10			μA
Reference Divider input: F <sub>R</sub>						
I <sub>IHR</sub>	High level input current	V <sub>IH</sub> = V <sub>DD</sub> = 2.95V			300	μA
I <sub>ILR</sub>	Low level input current	V <sub>IL</sub> = 0, V <sub>DD</sub> = 2.95V	-300			μA
Counter and phase detector outputs: PD_̄D , PD_̄U						
V <sub>OLD</sub>	Output voltage LOW	I <sub>out</sub> = 6 mA			0.4	V
V <sub>OHD</sub>	Output voltage HIGH	I <sub>out</sub> = -3 mA	V <sub>DD</sub> - 0.4			V
Lock detect outputs: Cext, LD						
V <sub>OLC</sub>	Output voltage LOW, Cext	I <sub>out</sub> = 100 μA			0.4	V
V <sub>OHC</sub>	Output voltage HIGH, Cext	I <sub>out</sub> = -100 μA	V <sub>DD</sub> - 0.4			V
V <sub>OLL</sub>	Output voltage LOW, LD	I <sub>out</sub> = 1 mA			0.4	V

OBSOLETE

**Table 5. AC Characteristics @ 25°C, V<sub>DD</sub> = 2.8V, unless otherwise noted**

Symbol	Parameter	Condition	Min	Typical	Max	Unit
Control interface and latches (see Figures 14 and 15)						
f <sub>Clk</sub>	Serial data clock frequency <sup>1</sup>				10	MHz
t <sub>ClkH</sub>	Serial clock HIGH time		30			ns
t <sub>ClkL</sub>	Serial clock LOW time		30			ns
t <sub>DSU</sub>	SDATA set-up time after SCLK rising edge		10			ns
t <sub>DHLD</sub>	SDATA hold time after SCLK rising edge		10			ns
t <sub>PW</sub>	S_WR pulse width		30			ns
t <sub>CWR</sub>	SCLK rising edge to S_WR rising edge		30			ns
t <sub>CE</sub>	SCLK falling edge to E_WR transition		30			ns
t <sub>WRC</sub>	S_WR falling edge to SCLK rising edge		30			ns
t <sub>EC</sub>	E_WR transition to SCLK rising edge		30			ns
t <sub>MDO</sub>	MSEL data out delay after F <sub>IN</sub> rising edge	C <sub>L</sub> = 12 pF		8		ns
Main divider 10/11 (including prescaler)						
F <sub>IN</sub>	Operating frequency		800		5000	MHz
P <sub>F<sub>IN</sub></sub>	Input sensitivity	External AC coupling 800 MHz – < 4 GHz 4 GHz – 5 GHz		-10 <sup>2</sup> -5 <sup>2</sup>	-5 0	dBm dBm
Main divider 5/6 (including prescaler)						
F <sub>IN</sub>	Operating frequency		800		4000	MHz
P <sub>F<sub>IN</sub></sub>	Input sensitivity	External AC coupling 800 MHz – 4 GHz		-10 <sup>2</sup>	-5	dBm
Main divider (prescaler bypassed)						
F <sub>IN</sub>	Operating frequency		50		800	MHz
P <sub>F<sub>IN</sub></sub>	Input sensitivity	External AC coupling 50 MHz – 800 MHz		-15 <sup>2</sup>	-10	dBm
Reference divider						
F <sub>R</sub>	Operating frequency				100	MHz
P <sub>F<sub>R</sub></sub>	Reference input power <sup>2</sup>	Single-ended input	-5 <sup>4</sup>		7	dBm
Phase detector						
f <sub>c</sub>	Comparison frequency				100	MHz

**Table 5. AC Characteristics @ 25°C, V<sub>DD</sub> = 2.8V, unless otherwise noted (continued)**

Symbol	Parameter	Condition	Min	Typical	Max	Unit
Single-sideband (SSB) phase noise 5/6 prescaler (F <sub>IN</sub> = 3 GHz, P <sub>F<sub>R</sub></sub> = +5 dBm, f <sub>c</sub> = 50 MHz, LBW = 500 kHz) <sup>5</sup>						
Φ <sub>N</sub>	Phase noise	100 Hz offset		-100		dBc/Hz
Φ <sub>N</sub>	Phase noise	1 kHz offset		-109		dBc/Hz
Φ <sub>N</sub>	Phase noise	10 kHz offset		-118		dBc/Hz
Φ <sub>N</sub>	Phase noise	100 kHz offset		-118		dBc/Hz
SSB phase noise 10/11 prescaler (F <sub>IN</sub> = 3 GHz, P <sub>F<sub>R</sub></sub> = +5 dBm, f <sub>c</sub> = 50 MHz, LBW = 500 kHz) <sup>5</sup>						
Φ <sub>N</sub>	Phase noise	100 Hz offset		-98		dBc/Hz
Φ <sub>N</sub>	Phase noise	1 kHz offset		-104		dBc/Hz
Φ <sub>N</sub>	Phase noise	10 kHz offset		-111		dBc/Hz
Φ <sub>N</sub>	Phase noise	100 kHz offset		-117		dBc/Hz
Phase noise figure of merit (FOM) <sup>5</sup>						
FOM <sub>flicker</sub>	Flicker figure of merit	5/6 prescaler		-268		dBc/Hz
		10/11 prescaler		-263		dBc/Hz
FOM <sub>floor</sub>	Floor figure of merit	5/6 prescaler		-230		dBc/Hz
		10/11 prescaler		-229		dBc/Hz
FOM <sub>flicker</sub>	PN <sub>flicker</sub> = FOM <sub>flicker</sub> + 20log (F <sub>IN</sub> ) - 10log (f <sub>offset</sub> )					dBc/Hz
FOM <sub>floor</sub>	PN <sub>floor</sub> = FOM <sub>floor</sub> + 10log (f <sub>c</sub> ) + 20log (F <sub>IN</sub> /f <sub>c</sub> )					dBc/Hz
FOM <sub>total</sub> , Φ <sub>N</sub>	PN = 10log [10 <sup>(PN<sub>flicker</sub>/10)</sup> + 10 <sup>(PN<sub>floor</sub>/10)</sup> ]					dBc/Hz

- Notes:
- f<sub>clk</sub> is verified during the functional pattern test. Serial programming sections of the functional pattern are clocked at 10 MHz to verify f<sub>clk</sub> specification
  - 0 dBm minimum input power is recommended for improved phase noise performance when sine-wave is applied or a slew rate of 4V/ns minimum when using a square wave
  - CMOS logic levels can be used to drive the reference input. If the V<sub>DD</sub> of the CMOS driver matches the V<sub>DD</sub> of the PLL IC, then the reference input can be DC coupled. Otherwise, the reference input should be AC coupled. For sine-wave inputs, the minimum amplitude needs to be 0.5 V<sub>pp</sub>. The maximum level should be limited to prevent ESD diodes at the pin input from turning on. Diodes will turn on at one forward-bias diode drop above V<sub>DD</sub> or below GND. The DC voltage at the Reference input is V<sub>DD</sub>/2
  - +2 dBm or higher reference power is recommended for improved phase noise performance when a sine-wave is applied or a slew rate of 0.5V/ns minimum using a square wave
  - The phase noise can be separated into two normalized specifications: a floor figure of merit and a flicker figure of merit. To accurately measure the phase noise floor without the contribution of the flicker noise, the loop bandwidth is set to 500 kHz and the phase noise is measured at a frequency offset near 100 kHz. The flicker noise is measured at a frequency offset ≤ 1000 Hz. The formula assumes a -10 dB/decade slope versus frequency offset

Typical Performance Data @ 25°C, V<sub>DD</sub> = 2.8V, f<sub>C</sub> = 50 MHz and F<sub>IN</sub> = 3 GHz, unless otherwise noted

Figure 4. Typical Phase Noise (5/6 Prescaler)  
Loop Bandwidth = 500 kHz

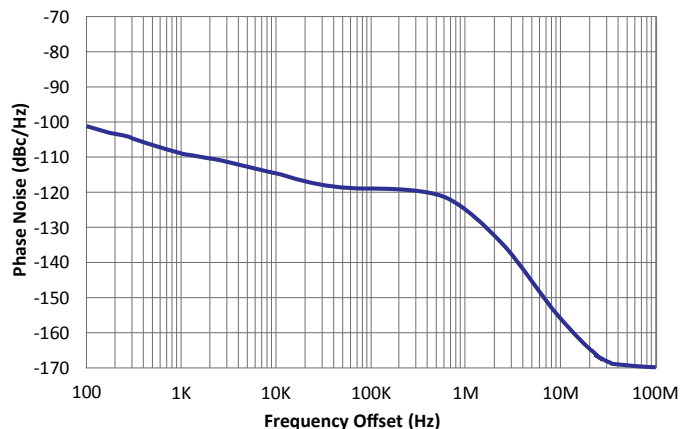


Figure 5. Typical Phase Noise (10/11 Prescaler)  
Loop Bandwidth = 500 kHz

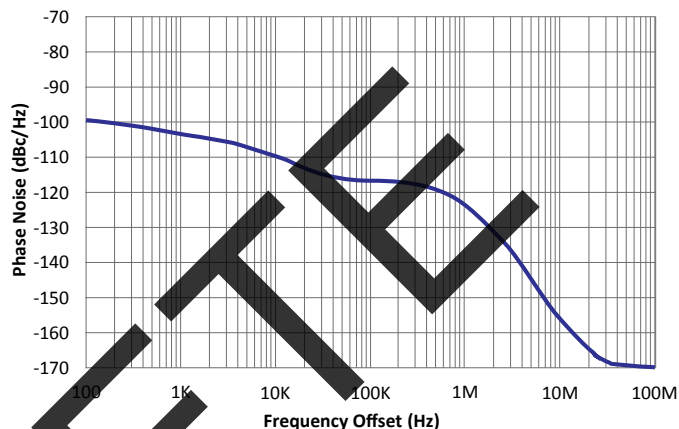


Figure 6. FOM vs. Temp and Supply Voltage (5/6 Prescaler)

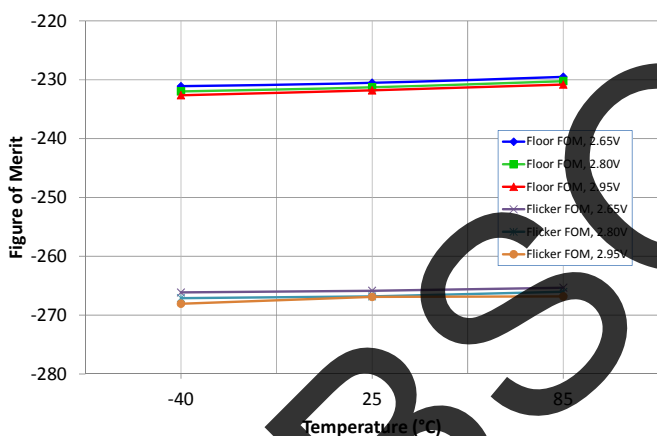


Figure 7. FOM vs. Temp and Supply Voltage (10/11 Prescaler)

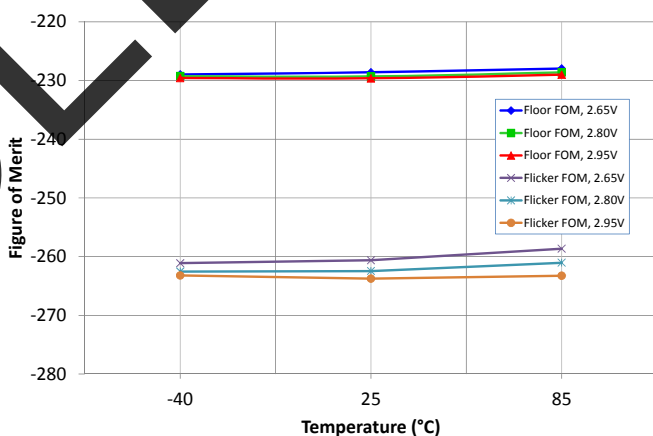


Figure 8. FOM vs. Reference Power and Temp (5/6 Prescaler)

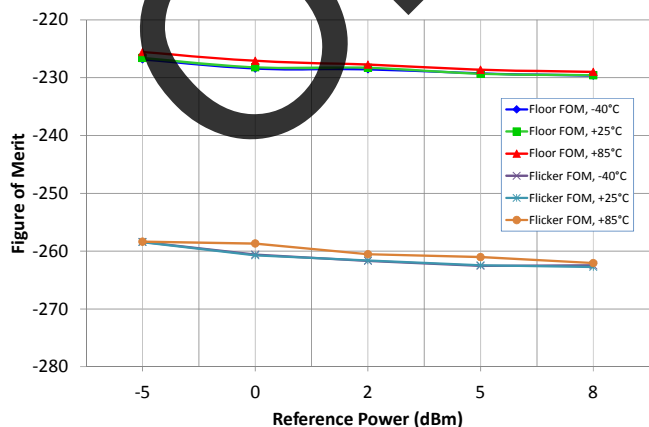
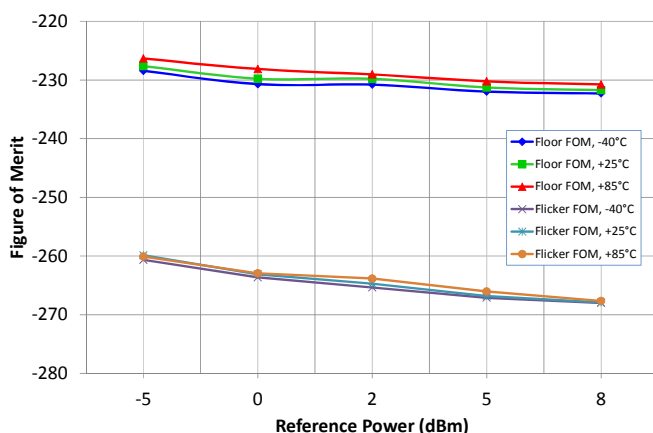


Figure 9. FOM vs. Reference Power and Temp (10/11 Prescaler)





Typical Performance Data @ 25°C,  $V_{DD} = 2.8V$ ,  $f_C = 50$  MHz and  $F_{IN} = 3$  GHz, unless otherwise noted

Figure 10. FOM vs. Input Power (5/6 Prescaler)

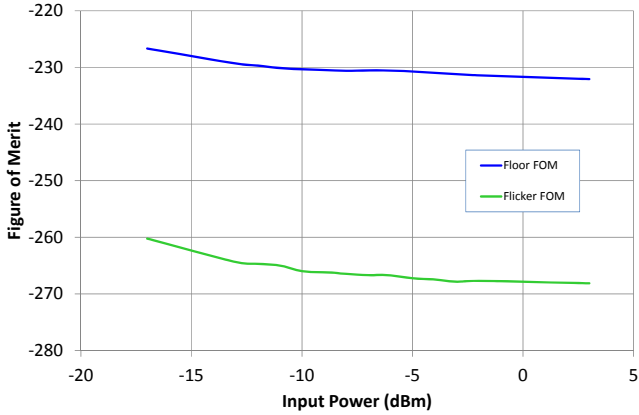


Figure 11. FOM vs. Input Power (10/11 Prescaler)

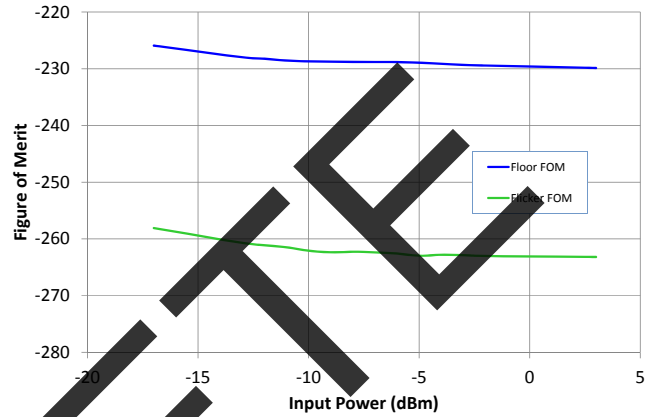


Figure 12. Input Sensitivity vs.  $F_{IN}$  and Temp (5/6 Prescaler,  $V_{DD} = 2.65V$ )<sup>1</sup>

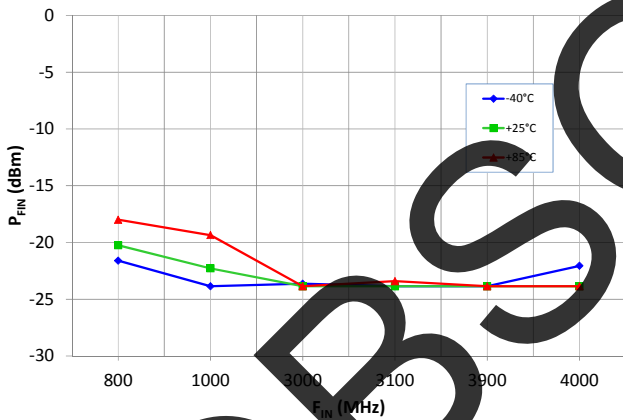
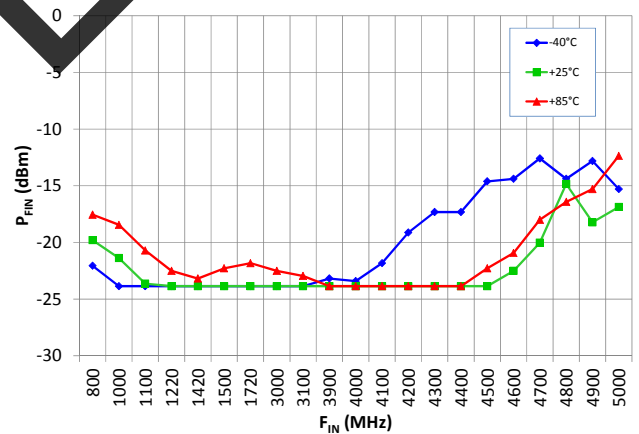


Figure 13. Input Sensitivity vs.  $F_{IN}$  and Temp (10/11 Prescaler,  $V_{DD} = 2.65V$ )<sup>1</sup>



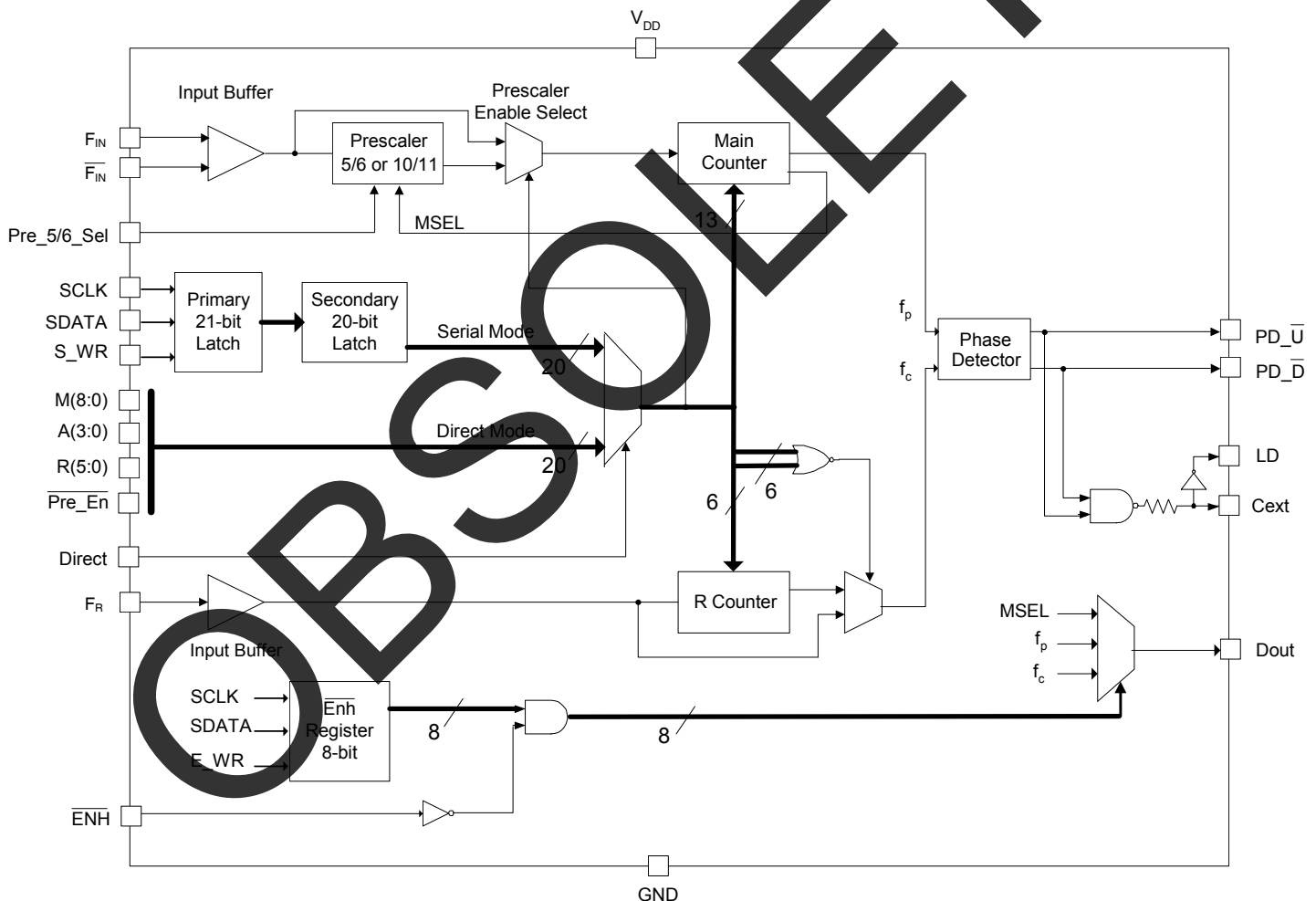
Note 1: Input sensitivity is the minimum input power level required for the PLL to maintain lock. Operating at these levels does not guarantee the SSB phase noise performance in Table 5

### Functional Description

The PE33241 consists of a prescaler, counters, a phase detector, and control logic. The dual modulus prescaler divides the VCO frequency by either 5/6 or 10/11, depending on the value of the modulus select. Counters “R” and “M” divide the reference and prescaler output, respectively, by integer values stored in a 21-bit register. An additional counter (“A”) is used in the modulus

select logic. The phase-frequency detector generates up and down frequency control signals. The control logic includes a selectable chip interface. Data can be written via serial bus or hardwired directly to the pins. There are also various operational and test modes and a lock detect output.

Figure 14. Functional Block Diagram



## Main Counter Chain

### Normal Operating Mode

The main counter chain divides the RF input frequency,  $F_{IN}$ , by an integer derived from the user-defined values in the “M” and “A” counters. It is composed of the 5/6 or 10/11 selectable modulus prescaler, modulus select logic, and 9-bit M counter. The prescaler can be set to either 5/6 or 10/11 based on the  $\overline{\text{Pre\_5/6\_Sel}}$  pin. Setting  $\overline{\text{Pre\_En}}$  “low” enables the 5/6 or 10/11 prescaler. Setting  $\overline{\text{Pre\_En}}$  “high” allows  $F_{IN}$  to bypass and power down the prescaler.

The output from the main counter chain,  $f_p$ , is related to the VCO frequency,  $F_{IN}$ , by the following equation:

$$f_p = F_{IN} / [10 \times (M + 1) + A] \quad (1)$$

where  $A \leq M + 1$ ,  $1 \leq M \leq 511$

Or

$$f_p = F_{IN} / [5 \times (M + 1) + A]$$

where  $A \leq M + 1$ ,  $1 \leq M \leq 511$

When the loop is locked,  $F_{IN}$  is related to the reference frequency,  $F_R$ , by the following equation:

$$F_{IN} = [10 \times (M + 1) + A] \times [F_R / (R + 1)] \quad (2)$$

where  $A \leq M + 1$ ,  $1 \leq M \leq 511$

Or

$$F_{IN} = [5 \times (M + 1) + A] \times [F_R / (R + 1)]$$

where  $A \leq M + 1$ ,  $1 \leq M \leq 511$

A consequence of the upper limit on A is that: in Integer-N mode, to obtain contiguous channels,

**$F_{IN}$  must be  $= 90 \times [F_R / (R + 1)]$  with 10/11 modulus**

**$F_{IN}$  must be  $= 20 \times [F_R / (R + 1)]$  with 5/6 modulus**

The A counter can accept values as high as 15, but in typical operation it will cycle from 0 to 9 between increments in M. Programming the M counter with the minimum allowed value of “1” will result in a minimum M counter divide ratio of “2”.

### Prescaler Bypass Mode

Setting  $\overline{\text{Pre\_En}}$  “high” allows  $F_{IN}$  to bypass and power down the prescaler. In this mode, the 5/6 or 10/11 prescaler and A register are not active, and the input VCO frequency is divided by the M counter directly. The following equation relates  $F_{IN}$  to the reference frequency,  $F_R$ :

$$F_{IN} = (M + 1) \times [F_R / (R + 1)] \quad (3)$$

where  $1 \leq M \leq 511$

### Reference Counter

The reference counter chain divides the reference frequency,  $F_R$ , down to the phase detector comparison frequency,  $f_c$ .

The output frequency of the 6-bit R counter is related to the reference frequency by the following equation:

$$f_c = F_R / (R + 1) \quad (4)$$

where  $0 \leq R \leq 63$

Note that programming R with “0” will pass the reference frequency,  $F_R$ , directly to the phase detector.

### Serial Interface Mode

While the E\_WR input is “low” and the S\_WR input is “low”, serial input data (SDATA input), B<sub>0</sub> to B<sub>20</sub>, is clocked serially into the primary register on the rising edge of SCLK, MSB (B<sub>0</sub>) first. The contents from the primary register are transferred into the secondary register on the rising edge of S\_WR according to the timing diagram shown in Figure 15. Data is transferred to the counters as shown in Table 6.

While the E\_WR input is “high” and the S\_WR input is “low”, serial input data (SDATA input), B<sub>0</sub> to B<sub>7</sub>, is clocked serially into the enhancement register on the rising edge of SCLK, MSB (B<sub>0</sub>) first. The enhancement register is double buffered

to prevent inadvertent control changes during serial loading, with buffer capture of the serially-entered data performed on the falling edge of E\_WR according to the timing diagram shown in Figure 15. After the falling edge of E\_WR, the data provides control bits as shown in Table 7 with bit functionality enabled by asserting the ENH input “low”.

### Direct Interface Mode

Direct Interface Mode is selected by setting the Direct input “high”.

Counter control bits are set directly at the pins as shown in Table 6 and Table 7.

**Table 6. Primary Register Programming**

Interface Mode	ENH	R <sub>5</sub>	R <sub>4</sub>	M <sub>8</sub>	M <sub>7</sub>	Pre_En	M <sub>6</sub>	M <sub>5</sub>	M <sub>4</sub>	M <sub>3</sub>	M <sub>2</sub>	M <sub>1</sub>	M <sub>0</sub>	R <sub>3</sub>	R <sub>2</sub>	R <sub>1</sub>	R <sub>0</sub>	A <sub>3</sub>	A <sub>2</sub>	A <sub>1</sub>	A <sub>0</sub>	ADDR
Serial *	1	B <sub>0</sub>	B <sub>1</sub>	B <sub>2</sub>	B <sub>3</sub>	B <sub>4</sub>	B <sub>5</sub>	B <sub>6</sub>	B <sub>7</sub>	B <sub>8</sub>	B <sub>9</sub>	B <sub>10</sub>	B <sub>11</sub>	B <sub>12</sub>	B <sub>13</sub>	B <sub>14</sub>	B <sub>15</sub>	B <sub>16</sub>	B <sub>17</sub>	B <sub>18</sub>	B <sub>19</sub>	B <sub>20</sub>
Direct	1	R <sub>5</sub>	R <sub>4</sub>	M <sub>8</sub>	M <sub>7</sub>	Pre_En	M <sub>6</sub>	M <sub>5</sub>	M <sub>4</sub>	M <sub>3</sub>	M <sub>2</sub>	M <sub>1</sub>	M <sub>0</sub>	R <sub>3</sub>	R <sub>2</sub>	R <sub>1</sub>	R <sub>0</sub>	A <sub>3</sub>	A <sub>2</sub>	A <sub>1</sub>	A <sub>0</sub>	0

\* Serial data clocked serially on SCLK rising edge while E\_WR “low” and captured in secondary register on S\_WR rising edge



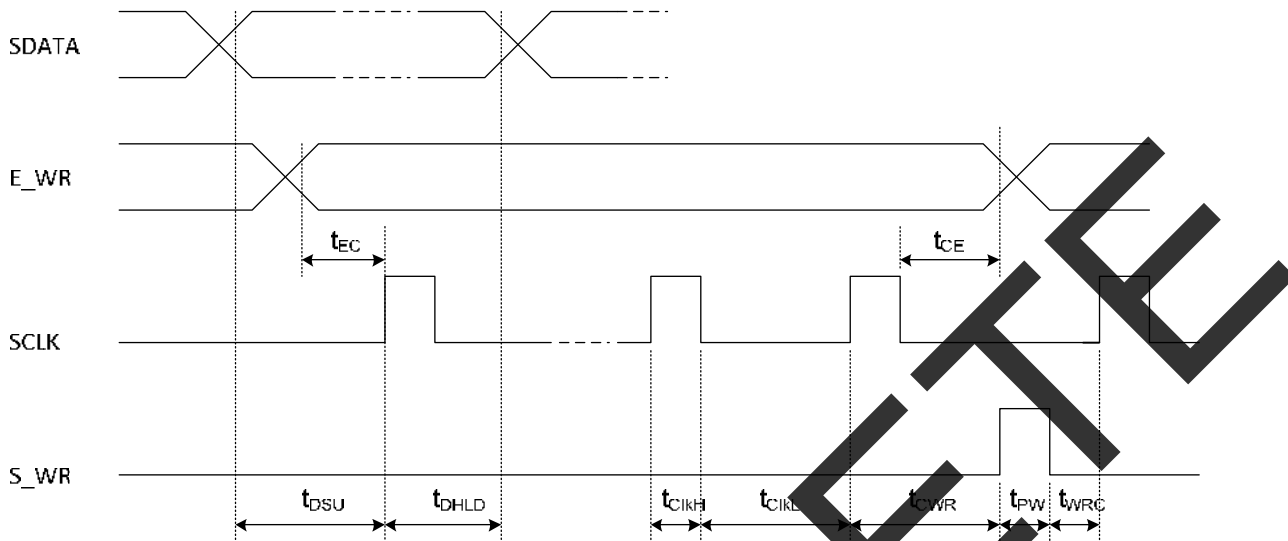
**Table 7. Enhancement Register Programming**

Interface Mode	ENH	Direct	Reserved	Reserved	f <sub>p</sub> output	Power Down	Counter load	MSEL output	f <sub>c</sub> output	LD Disable
Serial*	0	0	B <sub>0</sub>	B <sub>1</sub>	B <sub>2</sub>	B <sub>3</sub>	B <sub>4</sub>	B <sub>5</sub>	B <sub>6</sub>	B <sub>7</sub>

\* Serial data clocked serially on SCLK rising edge while E\_WR “high” and captured in the double buffer on E\_WR falling edge.



**Figure 15. Serial Interface Mode Timing Diagram**



### Enhancement Register

The functions of the enhancement register bits are shown below with all bits active “high”.

**Table 8. Enhancement Register Bit Functionality**

Bit	Bit Function	Description
Bit 0	Reserve*	Reserved
Bit 1	Reserve**	Reserved
Bit 2	$f_o$ output	Drives the M counter output onto the Dout output
Bit 3	Power down	Power down of all functions except programming interface
Bit 4	Counter load	Immediate and continuous load of counter programming
Bit 5	MSEL output	Drives the internal dual modulus prescaler modulus select (MSEL) onto the Dout output
Bit 6	$f_o$ output	Drives the reference counter output onto the Dout output
Bit 7	LD Disable	Disables the LD pin for quieter operation

\*\* Program to 0

## Phase Detector

The phase detector is triggered by rising edges from the main counter ( $f_p$ ) and the reference counter ( $f_c$ ). It has two outputs, namely  $PD_{\bar{U}}$ , and  $PD_{\bar{D}}$ . If the divided VCO leads the divided reference in phase or frequency ( $f_p$  leads  $f_c$ ),  $PD_{\bar{D}}$  pulses “low”. If the divided reference leads the divided VCO in phase or frequency ( $f_r$  leads  $f_p$ ),  $PD_{\bar{U}}$  pulses “low”. The width of either pulse is directly proportional to phase offset between the two input signals,  $f_p$  and  $f_c$ . The phase detector gain is 400 mV/radian.

$PD_{\bar{U}}$  and  $PD_{\bar{D}}$  are designed to drive an active loop filter which controls the VCO tune voltage.  $PD_{\bar{U}}$  pulses result in an increase in VCO frequency and  $PD_{\bar{D}}$  results in a decrease in VCO frequency.

A lock detect output, LD is also provided, via the pin Cext. Cext is the logical “NAND” of  $PD_{\bar{U}}$  and  $PD_{\bar{D}}$  waveforms, which is driven through a series 2k ohm resistor. Connecting Cext to an external shunt capacitor provides integration. Cext also drives the input of an internal inverting comparator with an open drain output. Thus LD is an “AND” function of  $PD_{\bar{U}}$  and  $PD_{\bar{D}}$ . See *Figure 14* for a functional block diagram of this circuit.

OBSOLETE

## Evaluation Board

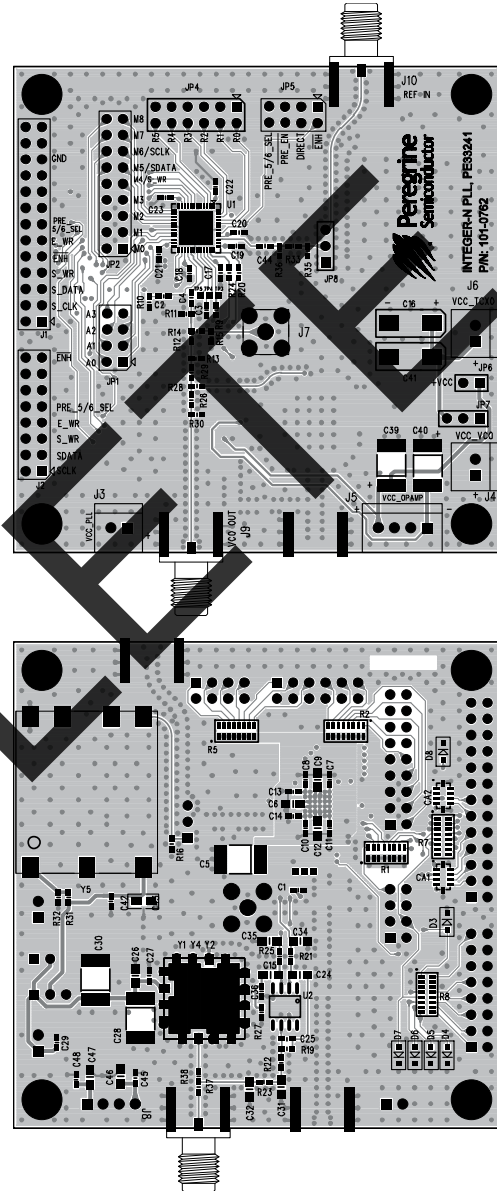
The PE33241 evaluation board was designed to demonstrate optimal phase noise performance when using an external and stable low noise reference source. The device may be programmed serially using the USB interface board with the applications software or directly by using jumpers to set the register values. Additionally, an external VCO may be used for specific operating frequencies.

The evaluation board consists of a four layer stack with two outer layers made of Rogers 4350B ( $\epsilon_r = 3.48$ ) and two inner layers of FR406 ( $\epsilon_r = 4.80$ ). The 12 mil (0.30 mm) thick inner layers provide ground planes for the RF transmission lines. The total thickness of the board is 62 mils (1.57 mm).

Figure 16. Evaluation Kit

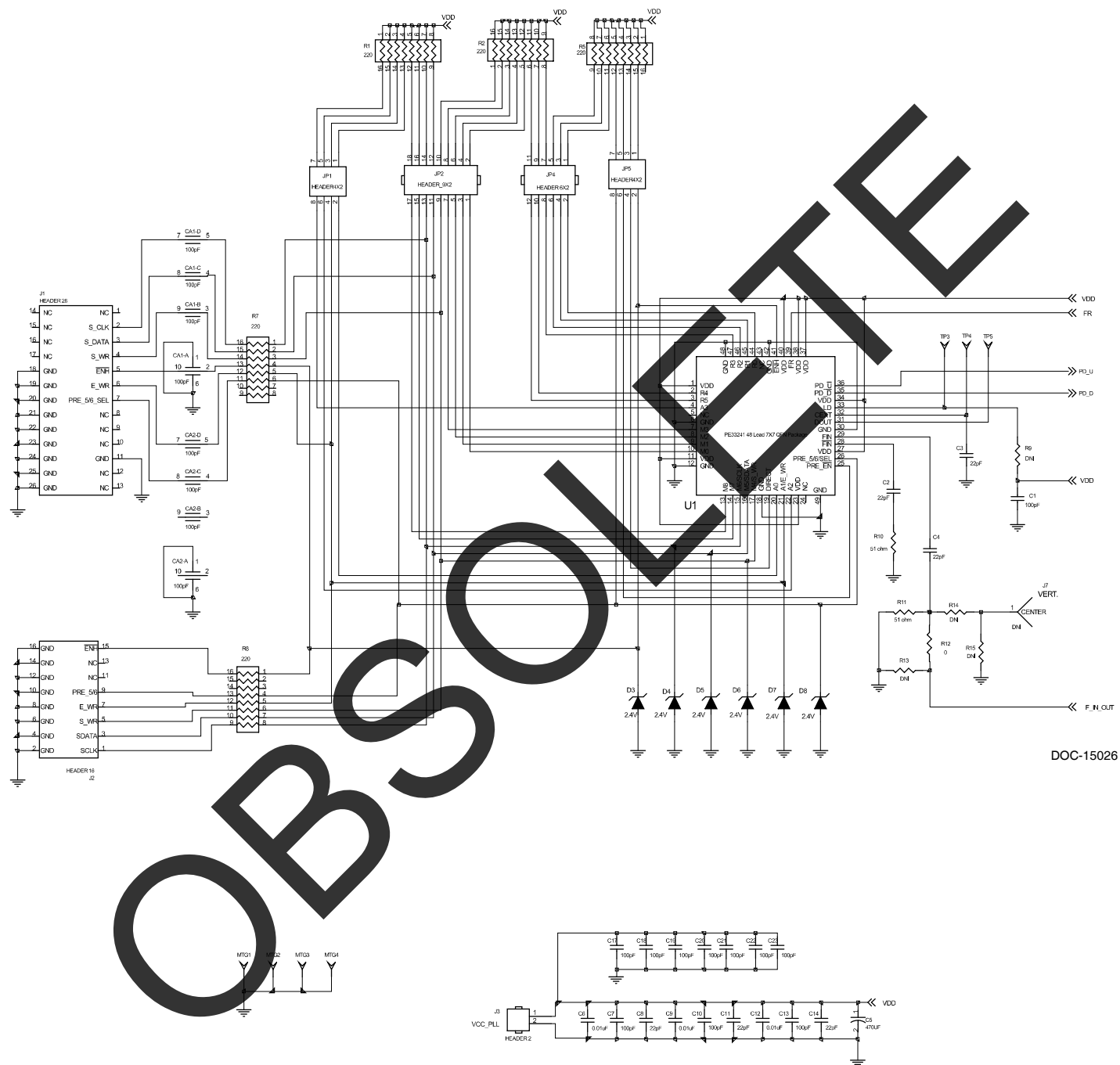


Figure 17. Evaluation Board Layout



PRT-50562

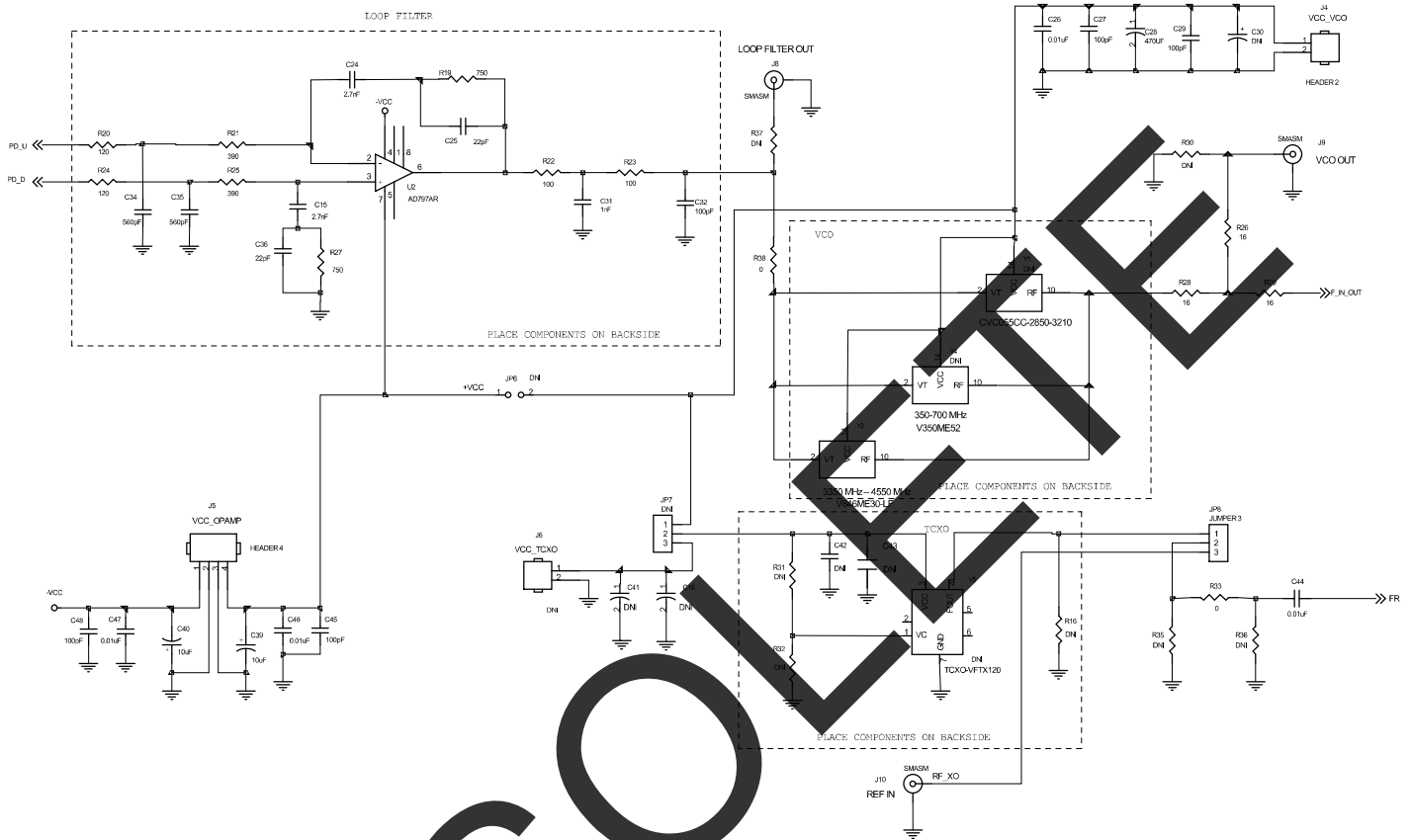
Figure 18. Evaluation Board Schematic



DOC-15026



Figure 18. Evaluation Board Schematic (continued)



OBSOLETE

Figure 19. Package Drawing  
48-lead 7x7 mm QFN

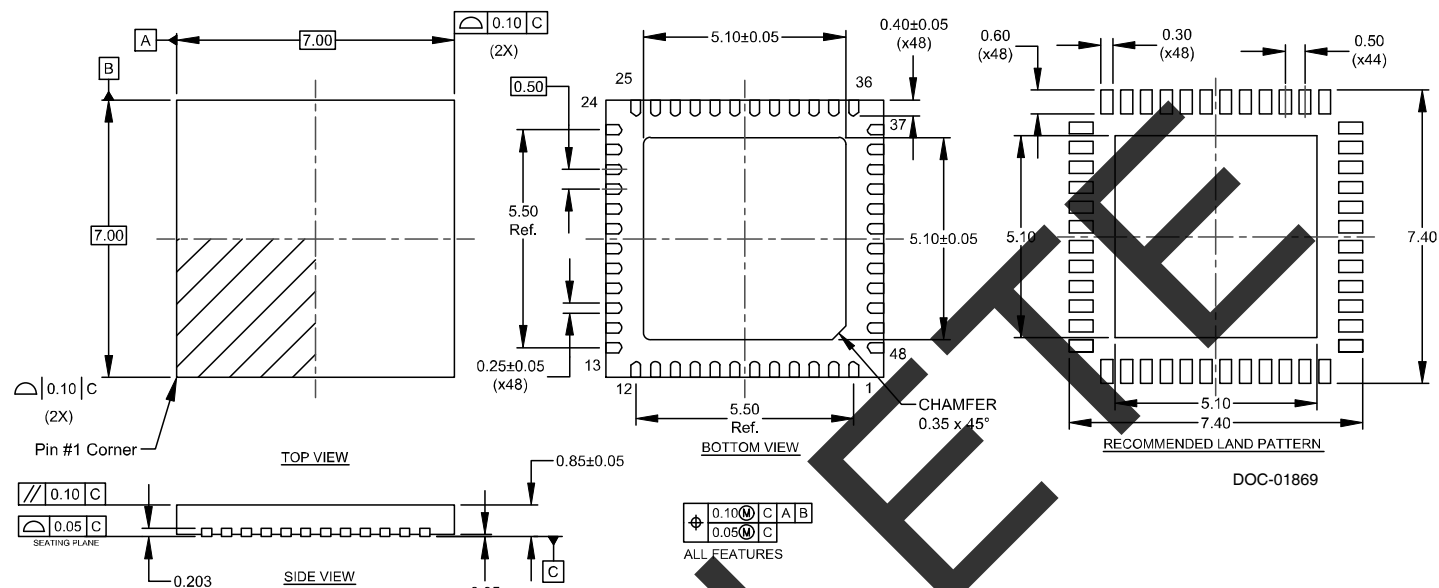


Figure 20. Top Marking Specifications



- = Pin 1 designator
- LLLLLL = Lot number
- YYWW = Date code

DOC-51207

Figure 21. Tape and Reel Drawing

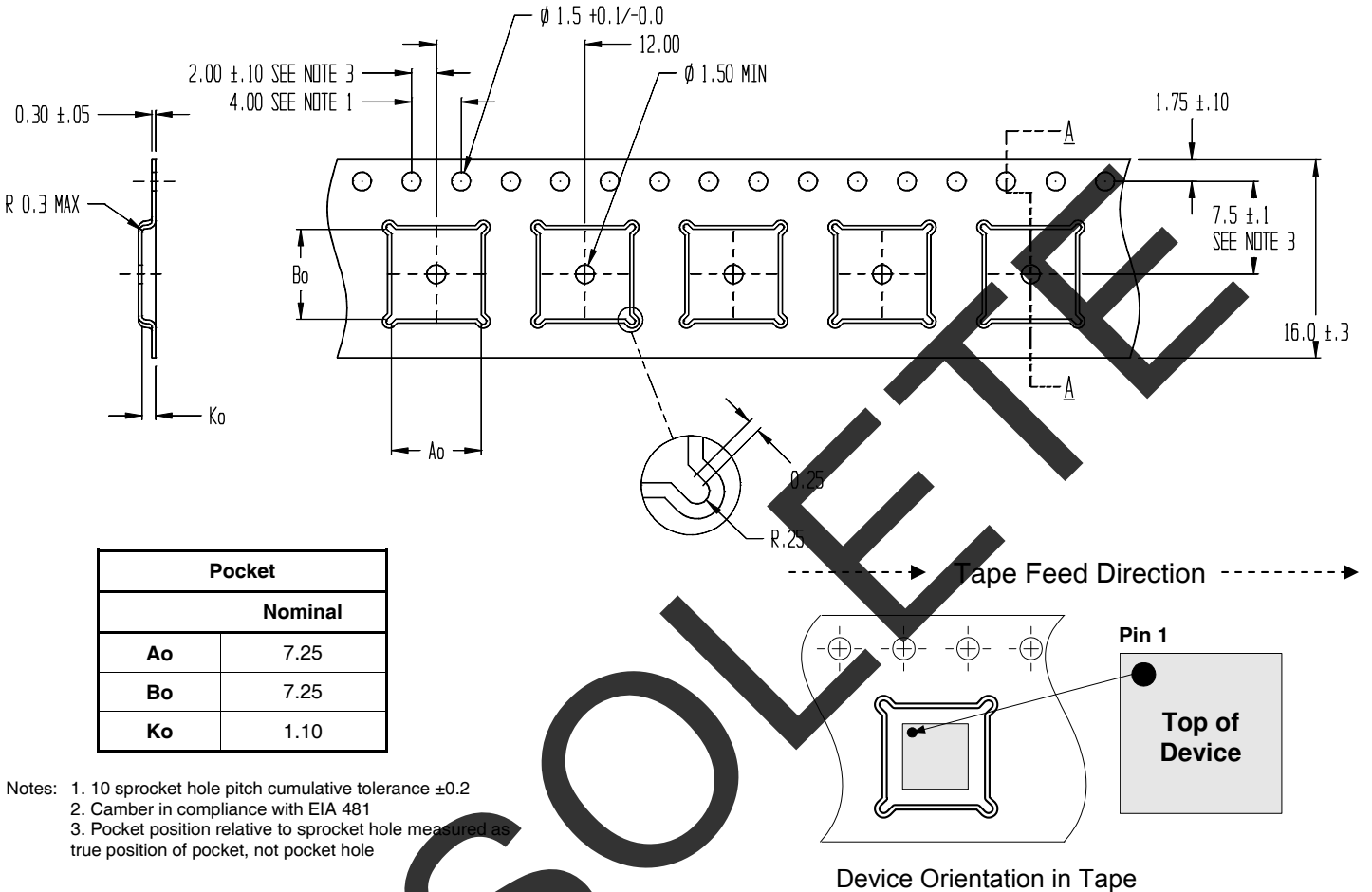


Table 9. Ordering Information

Order Code	Description	Package	Shipping Method
PE33241MLEA-X	PE33241 Integer-N PLL frequency synthesizer	48-lead 7x7 mm QFN	500 Units / T&R
EK33241-13	PE33241 Evaluation Kit	Evaluation kit	1 / Box

Sales Contact and Information

For sales and contact information please visit [www.psemi.com](http://www.psemi.com).

**Advance Information:** The product is in a formative or design stage. The datasheet contains design target specifications for product development. Specifications and features may change in any manner without notice.  
**Preliminary Specification:** The datasheet contains preliminary data. Additional data may be added at a later date. Peregrine reserves the right to change specifications at any time without notice in order to supply the best possible product.  
**Product Specification:** The datasheet contains final data. In the event Peregrine decides to change the specifications, Peregrine will notify customers of the intended changes by issuing a CNF (Customer Notification Form).  
 The information in this datasheet is believed to be reliable. However, Peregrine assumes no liability for the use of this information. Use shall be entirely at the user's own risk.

No patent rights or licenses to any circuits described in this datasheet are implied or granted to any third party. Peregrine's products are not designed or intended for use in devices or systems intended for surgical implant, or in other applications intended to support or sustain life, or in any application in which the failure of the Peregrine product could create a situation in which personal injury or death might occur. Peregrine assumes no liability for damages, including consequential or incidental damages, arising out of the use of its products in such applications.  
 The Peregrine name, logo, UltraCMOS and UTSi are registered trademarks and HaRP, MultiSwitch and DuNE are trademarks of Peregrine Semiconductor Corp. Peregrine products are protected under one or more of the following U.S. Patents: <http://patents.psemi.com>.