

# 2024-2025 Product Catalog

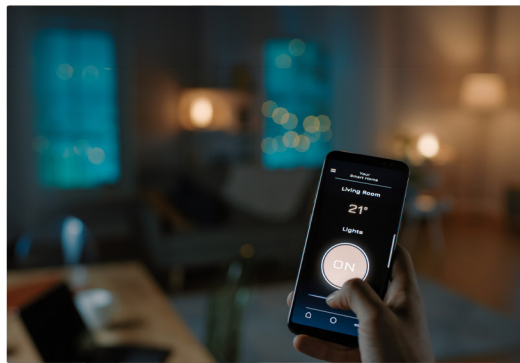
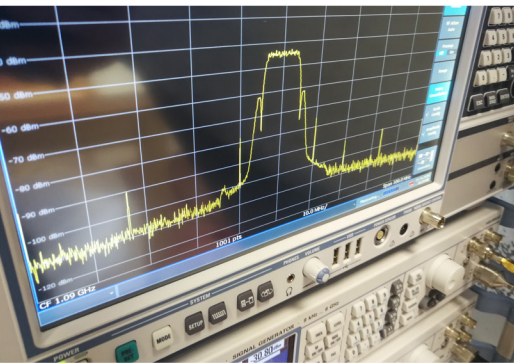
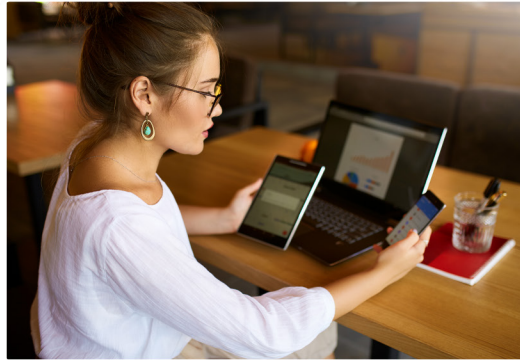

**Semi**<sup>®</sup>  
A Murata Company

# Contents

<b>About pSemi</b> .....	<b>2</b>	<b>Attenuators</b> .....	<b>13</b>
<b>Design &amp; Application Support</b> .....	<b>3</b>	Wired Broadband RF Digital Step Attenuators	
<b>Download Our sNp Viewer Software</b> .....	<b>3</b>	Glitchless RF Digital Step Attenuators	
<b>Technical Resources</b> .....	<b>3</b>	General-purpose RF Digital Step Attenuators	
<b>New &amp; Upcoming Products</b> .....	<b>4</b>	<b>Phase &amp; Amplitude Control</b> .....	<b>14</b>
Ultra-wideband Switch		Phase Shifter	
2.4 GHz IoT FEM		Monolithic Phase & Amplitude Controllers (MPACs)	
Sub-6 GHz.....	<b>5</b>	Digital Tunable Capacitors (DTCs)	
6 to 8 GHz		<b>Front-end Modules</b> .....	<b>15</b>
Test & Measurement		2.4 GHz IoT FEM	
<b>Recent Product Launches</b> .....	<b>6</b>	<b>Tx/Rx Modules</b> .....	<b>15</b>
Switch + LNA Module		Beamforming Front End	
High-isolation RF Switches		<b>Integrated Products</b> .....	<b>15</b>
<b>Complete Switch Portfolio</b> .....	<b>7</b>	Switch + LNA Module	
<b>Switches by Application</b> .....	<b>9</b>	<b>Mixers &amp; Limiters</b> .....	<b>16</b>
High-linearity RF Switches		Power Limiters	
High-isolation RF Switches		Up-Down Converter	
Low Insertion Loss RF Switches.....	<b>10</b>	Prescaler	
75Ω Wired Broadband Switches		Mixers	
50Ω Broadband RF Switches.....	<b>11</b>	<b>UltraCMOS® Technology</b> .....	<b>17</b>
50Ω High-power Switches		<b>High-performance RF Products</b> .....	<b>18</b>
Antenna Tuning Switches.....	<b>12</b>	<b>Quality &amp; Reliability</b> .....	<b>19</b>
Automotive Switches		<b>Packaging</b> .....	<b>19</b>
Extended Temperature RF Switches			

## Intelligent Electronics

### for the Connected World

At pSemi, innovation is at the core of our mission, not a motto. We explore, discover, and invent new ways to make electronics for the connected world smaller, thinner and better. Our cutting-edge RF products are designed with power management in mind and push the boundaries of performance, leading the way in connectivity, automotive, wireless infrastructure, test and measurement, and a broad variety of performance-based multi-market applications.

We empower our customers by providing solutions that enable them to make their products. Our relentless pursuit of innovation translates to real-world benefits in the devices and experiences we rely on every day. In fact, pSemi’s industry-leading technology has been used in countless ways from space exploration to the depths of the ocean.

pSemi products are everywhere, and we’re proud to contribute to the advancement of society by being designed into smartphones and laptops, asset tracking equipment, wearables, next-generation 5G infrastructure, and so much more.

# Design & Application Support

Next-generation RF and mmWave designs require high-performance products and outstanding support. We work with companies of all sizes throughout the design process, from testing to completion. Our team is committed to providing a complete solution, from engineering excellence and proven manufacturing to global sales and technical support.



## Contact Our Support Team

Our global sales, technical support, quality and customer service teams are available to support you. Scan the QR code to visit our website's support page to submit a request.



# Download Our sNp Viewer Software

- ✓ View/print multiple S-parameter files in various formats: Smith, polar, magnitude, phase, and phase vs. amplitude charts
- ✓ Perform time-domain analysis
- ✓ Build a lookup table of phase/amplitude settings
- ✓ Save pivot tables
- ✓ Save re-formatted S-parameter files, and adjust ports and frequencies

Visit our [website](#) to learn more



# Technical Resources

You can find helpful technical resources on our product pages at [psemi.com](#).

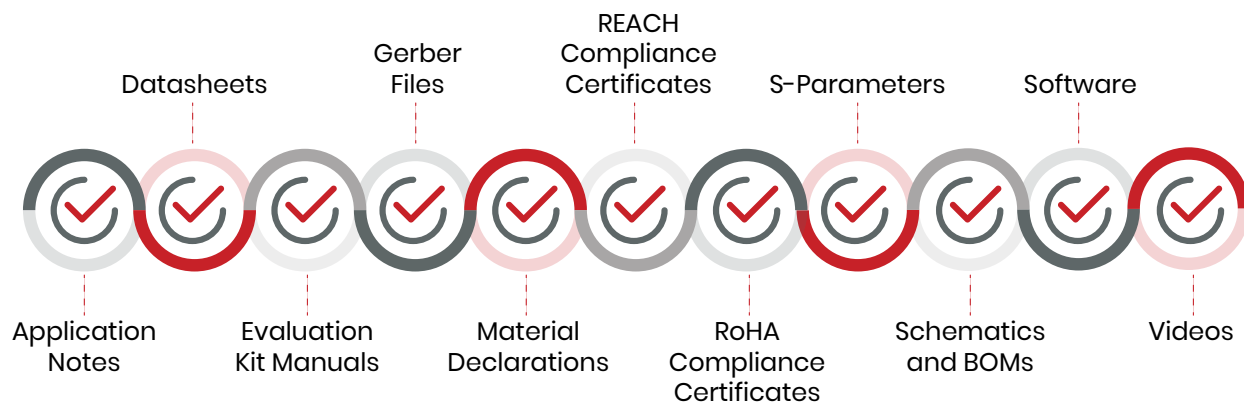



Visit Our Website for the latest

# New & Upcoming Products

## Ultra-wideband Switch

The PE423211 is a HaRP™ technology-enhanced reflective 50Ω SPDT RF switch designed for use in high-performance ISM, WLAN 802.11 a/b/g/n/ac/ax, Bluetooth® and UWB applications. The PE423211 is AEC-Q100 Grade-2 certified and supports bandwidths up to 10.6 GHz including secure car access, telematics, sensing, infotainment, in-cabin monitoring systems (ICMS), and general-purpose switching.

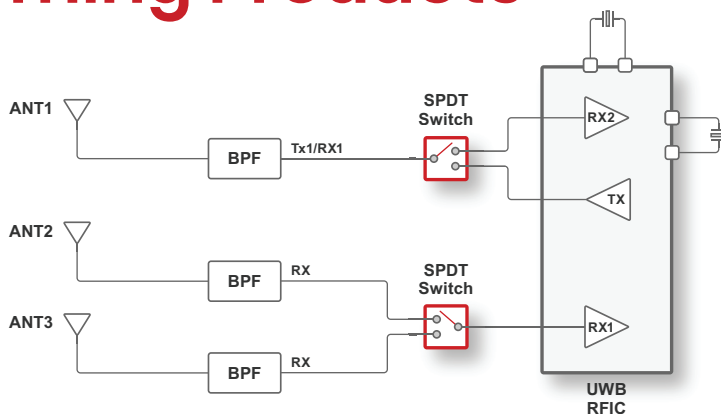

Product Description <sup>1</sup>	Part Number <sup>2</sup>	Operating Frequency (MHz)		Insertion Loss (dB)		Isolation (dB)		V <sub>DD</sub> Range (V)	Supply Current (nA)	Switching Time (ns)	ESD HBM (V)	Package (mm)
		Min	Max	Min	Max	Min	Max					
<b>NEW</b> SPDT, R	<b>PE423211</b>	300	10600	0.3	0.6	15	30	2.7-3.6	90	100	2000	6L 1.6x1.6 DFN

Note 1: Reflective (R) Note 2: Preliminary data. Visit our website for the latest information.



Smart Home

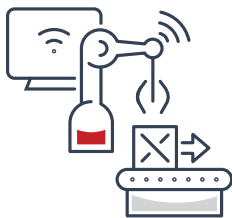

Factory



Asset Tracking



Wearables

## 2.4 GHz IoT FEM

The PE562212, built around the fast adoption of the Matter standard, enables connectivity across Thread, Zigbee®, Bluetooth® BDR/EDR, BLE, and low-medium throughput Wi-Fi® (MCS7) as well as 2.4 GHz proprietary applications.

Part Number*	Frequency (MHz)		P <sub>1.0dB</sub> (dBm)	P <sub>SAT</sub> (dBm)	Tx Gain (dB)	Tx Gain Control (dB)	Tx Gain Step (dB)	Rx NF (dB)	Rx Gain (dB)	Bypass Loss (dB)	Supply Voltage (V)	Package (mm)
	Min	Max										
<b>NEW</b> PE562212	2400	2483.5	21	24	23	15	1	1.6	15	-0.6	3.0-3.6	14-lead 1.8x1.8 LGA

Note: \* Preliminary data. Visit our website for the latest information.

## New & Upcoming Products (continued)

### Sub-6 GHz

The PE42447 is a HaRP™ technology-enhanced SP4T RF switch that supports a frequency range from 2.3 GHz to 5 GHz. It delivers extremely low insertion loss and high linearity with high input power handling capability making this device ideal for hybrid analog beamforming and in 5G massive multi-input, multi-output (mMIMO) applications. No blocking capacitors are required if DC voltage is not present on the RF ports.

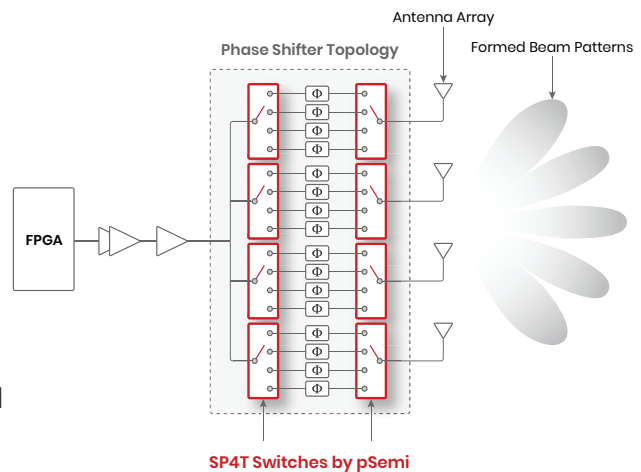

Product Description <sup>1</sup>	Part Number <sup>2</sup>	Operating Frequency (MHz)		IIP3 (dBm)	Pmax CW (dBm)	P0.1dB (dBm)	Insertion Loss (dB)		Isolation (dB)		V <sub>DD</sub> Range (V)	Switching Time (ns)	ESD HBM (V)	Package (mm)
		Min	Max				Min	Max	Min	Max				
<b>NEW</b> SP4T, R	<a href="#">PE42447</a>	2300	5000	85	40	50.3	0.32	0.62	39	26	4.5-5.5	7000	1000	20L 4x4 LGA

**Note 1:** Reflective (R) **Note 2:** Preliminary data. Visit our website for the latest information.

### 6 to 8 GHz

The PE44951 is a highly integrated two-way phase shifter with digitally controlled step attenuators that can be used across the 5.925 to 7.525 GHz frequency range. It is ideal for wireless infrastructure applications such as mMIMO macro and micro base stations as well as next-generation 5G solutions and small cell applications.

Part Number <sup>*</sup>	Operating Frequency (GHz)		Phase (deg) (Range/Steps/Bits)	Attenuation (dB) (Range/Steps/Bits)	Programming Mode	Package (mm)
	Min	Max				
<b>NEW</b> <a href="#">PE44951</a>	6.025	7.525	360 / 5.625 / 6	15.75 / 0.125 / 7	Serial	32L 5x5 LGA

**Note:** \* Preliminary data. Visit our website for the latest information.

### Test & Measurement

The PE42548 switch delivers RF performance and reliability to best meet challenging mmWave system designs from 9 kHz to 30 GHz as well as test and measurement applications.

Product Description <sup>1</sup>	Part Number <sup>2</sup>	Operating Frequency (MHz)		IIP3 (dBm)	Pmax CW (dBm)	P0.1dB (dBm)	Insertion Loss (dB)		Isolation (dB)		V <sub>DD</sub> Range (V)	Switching Time (ns)	ESD HBM (V)	Package (mm)
		Min	Max				Min	Max	Min	Max				
<b>NEW</b> SP4T, R	<a href="#">PE42548</a>	0.009	30000	52	29	27	1.1	2.3	33	41	3.15-3.45	60	600 <sup>3</sup> 2000 <sup>4</sup>	20L 3x2 LGA

**Note 1:** Reflective (R) **Note 2:** Preliminary data. Visit our website for the latest information. **Note 3:** ESD voltage HBM, all pins except RF. **Note 4:** ESD voltage HBM, RF pins.

# Recent Product Launches

## Switch + LNA Module

pSemi's dual-channel switch + LNA module incorporates high-power fail-safe switches and low-noise amplifiers with a bypass function. This receiver front-end module features low noise, excellent linearity and very low power consumption in a compact size and is ideally suited to 5G mMIMO applications.

Part Number	Operating Frequency (MHz)		OIP3 (dBm)	Pmax Avg (dBm)	Noise Figure (dB)	Isolation (dB, typ)	V <sub>DD</sub> Range (V)	Switching Time (μs)	Package (mm)
<b>PE53231</b>	3300	4200	32	43	0.9	47	4.75–5.25	0.5	40L 6×6 LGA

Note \*: 50% CTRL to 90% or 10% R.

## High-isolation RF Switches

Offering the highest isolation per form factor, our RF SOI SP4T switches feature best-in-class performance and industry-leading broadband frequency coverage up to 8.5 GHz for seamless integration into 4G/5G/5.5G base stations and mMIMO architecture.

Product Description <sup>1</sup>	Part Number	Operating Frequency (MHz)		IIP3 (dBm)	P0.1dB (dBm)	Insertion Loss (dB)		Isolation (dB)		V <sub>DD</sub> Range (V)	Switching Time (μs) <sup>2</sup>	ESD HBM (V)	Package (mm)
		Min	Max			Min	Max	Min	Max				
SP4T, A	<b>PE42445</b>	10	8000	60	37	0.7	1	52	64	2.3–5.5	0.25	2000	20L 3×3 LGA
SP4T, A	<b>PE42446</b>	10	8000	60	36.4	0.7	1	52	64	2.3–5.5	0.25	2000	24L 4×4 LGA

Note 1: Absorptive (A). Note 2: 50% CTRL to 90% or 10% R.

# Complete Switch Portfolio

Our broadband and general-purpose RF switches deliver an industry-leading combination of insertion loss, isolation, linearity and settling time, while routing RF signals to the selected RF port.

Visit our [website](#)  
to learn more



Product Description <sup>1</sup>	Part Number	Operating Frequency (MHz)		IIP3 (dBm)	Pmax CW (dBm)	P0.1dB (dBm)	Insertion Loss (dB)		Isolation (dB)		V <sub>DD</sub> Range (V)	Switching Time (μs) <sup>2</sup>	ESD HBM (V)	Package (mm)	Product Notes
		Min	Max				Min	Max	Min	Max					
SPDT, OR	<a href="#">PE613010</a>	100	3000	70	-	32	0.20	0.80	4	11	2.3-5.5	7	2000	10L 2x2 QFN	Tuning Control
SPDT, A/OR	<a href="#">PE42020</a>	0 Hz	8000	62	37	38	0.6	1.1	34	56	11-15 <sup>3</sup>	10	1000	20L 4x4 QFN	True DC
SPDT, A	<a href="#">PE42721</a>	5	2200	60	18	27	0.4	0.65	53	85	2.3-5.5	1	2000	12L 3x3 QFN	75 Termination
SPDT, A	<a href="#">PE42742<sup>7</sup></a>	5	2200	53	33	32 <sup>9</sup>	0.45	1.7	53.6	94	2.3-5.5	3	3500	20L 4x4 QFN	75Ω Termination
SPDT, A	<a href="#">PE42750<sup>7</sup></a>	5	2200	47.5	27.8	23.5 <sup>9</sup>	0.7	1.7	57	84	2.7-3.6	2	2000	12L 3x3 QFN	75Ω Termination
SPDT, A	<a href="#">PE4280</a>	5	2200	50	25.8	26 <sup>7</sup>	0.5	1.1	47	72	2.7-3.3	2	1000	20L 4x4 QFN	75Ω Termination
SPDT, A	<a href="#">PE4256</a>	5	3000	55	24	31	0.50	1.10	52	80	2.7-3.3	2	1000	20L 4x4 QFN	Low Insertion Loss
SPDT, A	<a href="#">PE4257</a>	10	3000	55	33	31	0.75	1.2	44	64	2.7-3.3	2	1000	20L 4x4 QFN	High Isolation
SPDT, A	<a href="#">PE42822</a>	700	3800	65	32	39.5	0.6	0.8	44	47	2.3-5.5	0.5	3000	16L 3x3 QFN	High Linearity
SPDT, A	<a href="#">PE4251</a>	10	4000	59	27	30.5	0.55	1.0	37	62	3.0-3.6	0.15	4000	8L MSOP	High Iso, Low IL
SPDT, A	<a href="#">PE42420<sup>4</sup></a>	20	6000	65	30	28	0.95	1.6	50	69	2.7-5.5	0.3	4000	20L 4x4 LGA	High Iso, Low IL
SPDT, A	<a href="#">PE42423</a>	100	8500	65	39	39.5	0.8	1.10	35	51	2.3-5.5	0.5	3000	16L 3x3 QFN	High Iso, Low IL
SPDT, A	<a href="#">PE42553</a>	0.009	8000	66	36	39	0.6	0.85	36	90	2.3-5.5	5.5	4000	16L 3x3 QFN	Broadband
SPDT, A	<a href="#">PE42520</a>	0.009	13000	66	36	39	0.6	2.0	18	90	2.3-5.5	5.5	4000	16L 3x3 QFN	Broadband
SPDT, A	<a href="#">PE42521</a>	0.009	13000	65	36	38	0.6	1.85	17	90	2.3-5.5	0.5	3000	16L 3x3 QFN	Broadband
SPDT, A	<a href="#">PE42522</a>	0.009	26500	59	30	33	0.7	5.3	20	80	2.3-5.5	3	3500	29L 4x4 LGA	Broadband
SPDT, R	<a href="#">PE42722</a>	5	1794	-	33	41	0.2	0.85	29	50	2.3-5.5	15	1500	32L 5x5 QFN	75Ω Termination
SPDT, R	<a href="#">PE42723</a>	5	1794	-	39	38	0.1	0.4	34	54	2.3-5.5	35	3000	12L 3x3 QFN	75Ω Termination
SPDT, R	<a href="#">PE42724</a>	5	1794	-	39	38	0.1	0.4	19	39	2.3-5.5	35	2000	12L 3x3 QFN	75Ω Termination
SPDT, R	<a href="#">PE42726</a>	5	1794	-	39	38	0.1	0.4	19	39	2.3-5.5	38	2000	12L 3x3 QFN	75Ω Termination
SPDT, R	<a href="#">PE42820</a>	30	2700	85	43	45.5	0.3	0.7	24	35	2.3-5.5	15	1500	32L 5x5 QFN	High Linearity
SPDT, R	<a href="#">PE42821</a>	100	2700	82	43	45.5	0.4	0.8	24	35	2.3-5.5	7	1500	32L 5x5 QFN	High Linearity
SPDT, R	<a href="#">PE42359<sup>4</sup></a>	10	3000	55	34	33.5	0.35	1.1	14	35	1.8-3.3	2	2000	6L SC70	Automotive
SPDT, R	<a href="#">PE4239</a>	10	3000	45	30	27	0.7	0.9	23	32	2.7-3.3	0.3	1500	6L SC70	Low Insertion Loss
SPDT, R	<a href="#">PE42421</a>	10	3000	55	35	30.5	0.35	0.5	20	30	1.8-3.3	1.5	2000	6L SC70	Low Insertion Loss
SPDT, R	<a href="#">PE4250</a>	10	3000	59	27	30.5	0.6	0.75	40	51	3.0-3.6	0.15	4000	8L MSOP	High Iso, Low IL
SPDT, R	<a href="#">PE4259</a>	10	3000	55	34	34	0.35	0.5	20	30	1.8-3.3	1.5	2000	6L SC70	Low Insertion Loss
SPDT, R	<a href="#">PE4245</a>	10	4000	45	30	27	0.6	0.7	32	42	2.7-3.3	0.2	1500	6L 3x3 DFN	Low Insertion Loss
SPDT, R	<a href="#">PE423422<sup>4</sup></a>	100	6000	73.5	32	34	0.25	0.9	16	41	2.3-5.5	2	1000	12L 2x2 QFN	Automotive
SPDT, R	<a href="#">PE42422</a>	5	6000	81	34	34	0.23	0.9	17	68	2.3-5.5	2	4000	12L 2x2 QFN	High Linearity
SPDT, R	<a href="#">PE42426</a>	5	6000	83	38	40	0.3	0.75	20	33	2.3-5.5	35	3000	12L 3x3 QFN	High Linearity
SPDT, R	<a href="#">PE42427</a>	5	6000	75	34	34	0.23	0.9	17	68	2.3-5.5	2	4000	12L 2x2 QFN	Low Insertion Loss

**Note 1:** Absorptive (A), reflective (R) or open reflective (OR).

**Note 2:** 50% CTRL to 90% or 10% RF.

**Note 3:** Requires external negative voltage (V<sub>SS</sub>, -1V to -15V) for operation.

**Note 4:** Operating temperature up to +105 °C.

**Note 5:** Fast switching (FS).

**Note 6:** Extended temperature (ET) range, -55 °C to +125 °C.

**Note 7:** Unpowered state: PE42742: RFC-RFI ON; PE42750: All ports terminated.

**Note 8:** P<sub>0.1dB</sub> levels.

**Note 9:** Peak power with LTE modulation.

**Note 10:** Preliminary data. Visit our website for the latest information.

**Note 11:** ESD voltage HBM, all pins except RF.

**Note 12:** ESD voltage HBM, RF pins.

## Complete Switch Portfolio (continued)

Product Description <sup>1</sup>	Part Number	Operating Frequency (MHz)		IIP3 (dBm)	Pmax CW (dBm)	PO.1dB (dBm)	Insertion Loss (dB)		Isolation (dB)		V <sub>DD</sub> Range (V)	Switching Time (μs) <sup>2</sup>	ESD HBM (V)	Package (mm)	Product Notes	
		Min	Max				Min	Max	Min	Max						
SPDT, R	<a href="#">PE42823</a>	700	6000	70	38.5	46	0.25	0.53	23	59	2.3–5.5	0.85	4500	16L 3×3 QFN	High Linearity	
SPDT, R	<a href="#">PE42424</a> <sup>4</sup>	100	8500	60	41	41 <sup>8</sup>	0.8	0.95	45	47	2.3–5.5	0.145	2500	6L 1.5×1.5 DFN	High Iso, Low IL, FS <sup>5</sup>	
<b>NEW</b>	SPDT, R	<a href="#">PE423211</a> <sup>10</sup>	300	10600	–	25	25 <sup>8</sup>	0.3	0.6	15	30	2.7–3.6	0.1	2000	6L 1.6×1.6 DFN	Automotive
SPDT, R	<a href="#">PE42524</a>	10	40000	52	27	32.5	0.6	5.5	33	84	–	0.225	2000	Flip Chip	Broadband	
SPDT, R	<a href="#">PE42525</a>	0.009	60000	48	29	35	0.9	2.7	36	80	–	0.008	1000	Flip Chip	Broadband, FS <sup>5</sup>	
SPDT, R	<a href="#">PE426525</a>	0.009	60000	48	27	35	0.9	2.7	36	80	–	0.008	1000	Flip Chip	Broadband, FS <sup>5</sup> , ET <sup>6</sup>	
SP3T, R	<a href="#">PE42430</a>	100	3000	66	30	33	0.45	0.55	30	40	3.0–5.5	0.5	45000	8L 1.5×1.5 DFN	High Iso, Low IL	
SP4T, A	<a href="#">PE42442</a>	30	6000	58	33	33	0.85	2.35	32	67	2.3–5.5	0.255	2000	24L 4×4 QFN	High Isolation	
SP4T, A	<a href="#">PE42441</a>	10	8000	58	31	31	0.8	1.2	31	45	3.0–3.55	5	2000	32L 5×5 LGA	High Iso, Low IL	
SP4T, A	<a href="#">PE42445</a>	10	8000	60	34	37	0.7	1	52	64	2.3–5.5	0.25	–	20L 3×3 LGA	High Iso, Low IL	
SP4T, A	<a href="#">PE42446</a>	10	8000	64	34	36.4	0.7	1	52	64	2.3–5.5	0.25	–	24L 4×4 LGA	High Iso, Low IL	
SP4T, A	<a href="#">PE42540</a>	0.00001	8000	58	30	33	0.7	1.2	27	84	3.0–3.6	5	2000	32L 5×5 LGA	Broadband	
SP4T, A	<a href="#">PE42542</a>	0.009	18000	58	30	33	0.7	3.9	27	90	2.3–5.5	3	3500	29L 4×4 LGA	Broadband	
SP4T, A	<a href="#">PE42543</a>	0.009	18000	59	30	33	0.7	4.1	29	90	2.3–5.5	0.5	2500	29L 4×4 LGA	Broadband	
SP4T, OR	<a href="#">PE613050</a>	5	3000	80	–	35.1	0.20	0.55	17	28	2.3–5.5	2	2000	12L 2×2 QFN	Tuning Control	
SP4T, R	<a href="#">PE423641</a> <sup>4</sup>	50	3000	68	35	37	0.5	0.95	22	32	2.65–3.3	1	2000	16L 3×3 QFN	Automotive	
SP4T, R	<a href="#">PE42440</a>	50	3000	67	33	41.5	0.45	0.85	22	34	2.7–3.3	2	2000	16L 3×3 QFN	Low Insertion Loss	
SP4T, R	<a href="#">PE42641</a>	100	3000	68	38	–	0.45	0.55	27.5	35	2.65–2.85	2	2000	16L 3×3 QFN	Low Insertion Loss	
SP4T, R	<a href="#">PE42443</a>	1800	5000	85	50 <sup>9</sup>	50	0.33	0.74	26	33	4.5–5.5	0.82	1000	20L 4×4 LGA	High Power High Linearity	
SP4T, R	<a href="#">PE42444</a>	1800	5000	85	50 <sup>9</sup>	50	0.32	0.68	25	38	4.5–5.5	0.86	1000	20L 4×4 LGA	High Power High Linearity	
<b>NEW</b>	SP4T, R	<a href="#">PE42447</a> <sup>10</sup>	2300	5000	85	40	50.3	0.32	0.62	39	26	4.5–5.5	7000	1000	20L 4×4 LGA	High Power High Linearity
<b>NEW</b>	SP4T, R	<a href="#">PE42548</a> <sup>10</sup>	0.009	30000	52	29	27	1.1	2.3	33	41	3.15–3.45	60	600 <sup>11</sup> 2000 <sup>12</sup>	20L 3×2 LGA	Broadband
SP4T, R	<a href="#">PE42546</a>	0.009	52000	48	29	27	1.1	3.8	23	41	3.15–3.45	0.06	2000	20L 3×3 LGA	Broadband	
SP4T, R	<a href="#">PE42545</a>	0.009	67000	49	30	28	1	4.5	22.5	46	3.15–3.45	0.06	2000	Flip Chip	Broadband	
SP5T, A	<a href="#">PE42451</a>	450	4000	58	33	35	1.6	2.25	50	68	2.7–3.3	0.2	3500	24L 4×4 QFN	High Isolation	
SP5T, A	<a href="#">PE42452</a>	450	4000	57	33	35	0.95	1.6	44	61	2.3–5.5	0.265	1500	24L 4×4 QFN	High Isolation	
SP6T, A	<a href="#">PE42462</a> <sup>4</sup>	10	8000	60	33	37.5	0.7	1.6	30	68	2.3–5.5	0.21	1000	24L 4×4 QFN	Broadband, High Iso	
SP6T, A	<a href="#">PE42562</a> <sup>4</sup>	0.009	8000	60	33	37.5	0.7	1.6	30	68	2.3–5.5	0.210	1000	24L 4×4 QFN	Broadband, Low IL	
SP6T, A	<a href="#">PE426462</a>	10	8000	60	31	37.5	0.7	1.6	30	68	2.3–5.5	0.210	1000	24L 4×4 QFN	Broadband, ET <sup>6</sup>	
SPDT, A	<a href="#">PE4256</a>	5	3000	55	24	31	0.50	1.10	52	80	2.7–3.3	2	1000	20L 4×4 QFN	Low Insertion Loss	
SP8T, A	<a href="#">PE42482</a> <sup>4</sup>	10	8000	60	33	37.5	0.7	1.6	30	85	2.3–5.5	0.227	1000	24L 4×4 QFN	Broadband, High Iso	
SP8T, A	<a href="#">PE42582</a> <sup>4</sup>	0.009	8000	60	33	37.5	0.7	1.6	30	85	2.3–5.5	0.227	1000	24L 4×4 QFN	Broadband, Low IL	
SP8T, A	<a href="#">PE426482</a>	10	8000	60	31	37.5	0.7	1.6	30	85	2.3–5.5	0.227	1000	24L 4×4 QFN	Broadband, ET <sup>6</sup>	
SPI2T, A	<a href="#">PE42412</a> <sup>4</sup>	10	8000	60	35	37.5	0.7	2.4	22	69	2.3–5.5	0.232	1000	32L 5×5 QFN	Broadband, High Iso	
SPI2T, A	<a href="#">PE42512</a> <sup>4</sup>	0.009	8000	60	33	37.5	0.7	2.4	22	69	2.3–5.5	0.232	1000	32L 5×5 QFN	Broadband, Low IL	
SPI2T, A	<a href="#">PE426412</a>	10	8000	60	31	37.5	0.7	2.4	22	69	2.3–5.5	0.232	1000	32L 5×5 QFN	Broadband, ET <sup>6</sup>	
SP(3/5)T, R	<a href="#">PE42850</a>	30	1000	42	42.5	45.5	0.25	0.35	30	36	2.3–5.5	15	1500	32L 5×5 QFN	High Linearity	
SP(3/5)T, R	<a href="#">PE42851</a>	100	1000	42	42.5	45.5	0.25	0.4	30	36	2.3–5.5	6	1500	32L 5×5 QFN	High Linearity	



# Switches by Application

## High-linearity RF Switches

Our high-linearity switches use HaRP™ technology to deliver unmatched linearity and excellent harmonics performance with best-in-class ESD and reliability for a wide variety of switching applications.

Visit our [website](#) to learn more



Product Description <sup>1</sup>	Part Number	Operating Frequency (MHz)		IIP3 (dBm)	Pmax CW (dBm)	P0.1dB (dBm)	Insertion Loss (dB)		Isolation (dB)		V <sub>DD</sub> Range (V)	Switching Time (μs) <sup>2</sup>	ESD HBM (V)	Package (mm)
		Min	Max				Min	Max	Min	Max				
SPDT, R	<a href="#">PE42422</a>	5	6000	81	34	34	0.23	0.9	17	68	2.3–5.5	2	4000	12L 2x2 QFN
SPDT, R	<a href="#">PE42426</a>	5	6000	83	38	40	0.3	0.75	20	33	2.3–5.5	35	3000	12L 3x3 QFN
SPDT, R	<a href="#">PE42427</a>	5	6000	75	34	34	0.23	0.9	17	68	2.3–5.5	2	4000	12L 2x2 QFN
SP4T, R	<a href="#">PE42443</a>	1800	5000	85	50 <sup>3</sup>	50	0.33	0.74	26	33	4.5–5.5	0.82	1000	20L 4x4 LGA
SP4T, R	<a href="#">PE42444</a>	1800	5000	85	50 <sup>3</sup>	50	0.32	0.68	25	38	4.5–5.5	0.86	1000	20L 4x4 LGA
<b>NEW</b>	<a href="#">PE42447<sup>4</sup></a>	2300	5000	85	40	50.3	0.32	0.62	39	26	4.5–5.5	7000	1000	20L 4x4 LGA

**Note 1:** Reflective (R). **Note 2:** 50% CTRL to 90% or 10% RF. **Note 3:** Peak power with LTE modulation.

**Note 4:** Preliminary data. Visit our website for the latest information.

## High-isolation RF Switches

Our high-isolation switches feature exceptional port-to-port isolation, insertion loss and switching time from SPDT to SPI2T configurations, ideal for filter bank switching and wireless signal routing applications supporting bandwidths up to 8.5 GHz.

Product Description <sup>1</sup>	Part Number	Operating Frequency (MHz)		IIP3 (dBm)	Pmax CW (dBm)	P0.1dB (dBm)	Insertion Loss (dB)		Isolation (dB)		V <sub>DD</sub> Range (V)	Switching Time (μs) <sup>2</sup>	ESD HBM (V)	Package (mm)
		Min	Max				Min	Max	Min	Max				
SPDT, A	<a href="#">PE42420<sup>3</sup></a>	20	6000	65	30	28	0.95	1.6	50	69	2.7–5.5	0.3	4000	20L 4x4 LGA
SPDT, A	<a href="#">PE42423</a>	100	8500	65	39	39.5	0.8	1.10	35	51	2.3–5.5	0.5	3000	16L 3x3 QFN
SPDT, A	<a href="#">PE4257</a>	10	3000	55	33	31	0.75	1.2	44	64	2.7–3.3	2	1000	20L 4x4 QFN
SPDT, R	<a href="#">PE42424<sup>3</sup></a>	100	8500	60	41	41 <sup>4</sup>	0.8	0.95	45	47	2.3–5.5	0.145	2500	6L 1.5x1.5 DFN
SP4T, A	<a href="#">PE42442<sup>3</sup></a>	30	6000	58	33	33	0.85	2.35	32	67	2.3–5.5	0.255	2000	24L 4x4 QFN
SP4T, A	<a href="#">PE42445</a>	10	8000	60	34	37	0.7	1	52	64	2.3–5.5	0.25	2000	20L 3x3 LGA
SP4T, A	<a href="#">PE42446</a>	10	8000	64	34	36.4	0.7	1	52	64	2.3–5.5	0.25	2000	24L 4x4 LGA
SP5T, A	<a href="#">PE42451</a>	450	4000	58	33	35	1.6	2.25	50	68	2.7–3.3	0.200	3500	24L 4x4 QFN
SP5T, A	<a href="#">PE42452<sup>3</sup></a>	450	4000	57	33	35	0.95	1.6	44	61	2.3–5.5	0.265	1500	24L 4x4 QFN
SP6T, A	<a href="#">PE42462<sup>3</sup></a>	10	8000	60	33	37.5	0.7	1.6	30	68	2.3–5.5	0.210	1000	24L 4x4 QFN
SP8T, A	<a href="#">PE42482<sup>3</sup></a>	10	8000	60	33	37.5	0.7	1.6	30	85	2.3–5.5	0.227	1000	24L 4x4 QFN
SPI2T, A	<a href="#">PE42412<sup>3</sup></a>	10	8000	60	35	37.5	0.7	2.4	22	69	2.3–5.5	0.232	1000	32L 5x5 QFN

**Note 1:** Absorptive (A) or reflective (R). **Note 2:** 50% CTRL to 90% or 10% RF. **Note 3:** Operating temperature up to +105 °C. **Note 4:** P1dB levels.

## Low Insertion Loss RF Switches

Our low insertion loss switches use HaRP™ technology to reduce gate lag and insertion loss drift, delivering industry-leading insertion loss and RF performance to wireless infrastructure, broadband and test and measurement applications.

Product Description <sup>1</sup>	Part Number	Operating Frequency (MHz)		IIP3 (dBm)	Pmax CW (dBm)	PO.1dB (dBm)	Insertion Loss (dB)		Isolation (dB)		V <sub>DD</sub> Range (V)	Switching Time (μs) <sup>2</sup>	ESD HBM (V)	Package (mm)
		Min	Max				Min	Max	Min	Max				
SPDT, A	<a href="#">PE4251</a>	10	4000	59	27	30.5	0.55	1.0	37	62	3.0–3.6	0.15	4000	8L MSOP
SPDT, A	<a href="#">PE4256</a>	5	3000	55	24	31	0.50	1.10	52	80	2.7–3.3	2	1000	20L 4×4 QFN
SPDT, R	<a href="#">PE4239</a>	10	3000	45	30	27	0.7	0.9	23	32	2.7–3.3	0.3	1500	6L SC70
SPDT, R	<a href="#">PE42421</a>	10	3000	55	35	30.5	0.35	0.5	20	30	1.8–3.3	1.5	2000	6L SC70
SPDT, R	<a href="#">PE4245</a>	10	4000	45	30	27	0.6	0.7	32	42	2.7–3.3	0.2	1500	6L 3×3 DFN
SPDT, R	<a href="#">PE4250</a>	10	3000	59	27	30.5	0.6	0.75	40	51	3.0–3.6	0.15	4000	8L MSOP
SPDT, R	<a href="#">PE4259</a>	10	3000	55	34	34	0.35	0.5	20	30	1.8–3.3	1.5	2000	6L SC70
SP3T, R	<a href="#">PE42430</a>	100	3000	66	30	30	0.45	0.55	30	40	3.0–5.5	0.500	4500	8L 1.5×1.5 DFN
SP4T, R	<a href="#">PE42440</a>	50	3000	67	33	41.5	0.45	0.85	22	34	2.7–3.3	2	2000	16L 3×3 QFN
SP4T, A	<a href="#">PE42441</a>	10	8000	58	31	31	0.8	1.2	31	45	3.0–3.55	5	2000	32L 5×5 LGA
SP4T, R	<a href="#">PE42641</a>	100	3000	68	38	–	0.45	0.55	27.5	35	2.65–2.85	2	2000	16L 3×3 QFN

**Note 1:** Absorptive (A) or reflective (R). **Note 2:** 50% CTRL to 90% or 10% RF.

## 75Ω Wired Broadband Switches<sup>1</sup>

Our high-performance 75Ω switches simplify your next RF design by providing excellent isolation, low insertion loss and a CMOS/TTL-compatible control to address the needs of wired broadband applications.

Product Description <sup>2</sup>	Part Number	Operating Frequency (MHz)		IIP3 (dBm)	Pmax CW (dBm)	PO.1dB (dBm)	Insertion Loss (dB)		Isolation (dB)		V <sub>DD</sub> Range (V)	Switching Time (μs) <sup>3</sup>	ESD HBM (V)	Package (mm)
		Min	Max				Min	Max	Min	Max				
SPDT, A	<a href="#">PE42721</a>	5	2200	60	18	27	0.4	0.65	53	85	2.3–5.5	1	2000	12L 3×3 QFN
SPDT, A	<a href="#">PE42742<sup>4</sup></a>	5	2200	53	33	32 <sup>5</sup>	0.45	1.7	53.6	94	2.3–5.5	3	3500	20L 4×4 QFN
SPDT, A	<a href="#">PE42750<sup>4</sup></a>	5	2200	47.5	27.8	23.5 <sup>5</sup>	0.7	1.7	57	84	2.7–3.6	2	2000	12L 3×3 QFN
SPDT, A	<a href="#">PE4280</a>	5	2200	50	25.8	26 <sup>5</sup>	0.5	1.1	47	72	2.7–3.3	2	1000	20L 4×4 QFN
SPDT, R	<a href="#">PE42722</a>	5	1794	–	33	41	0.2	0.85	29	50	2.3–5.5	15	1500	32L 5×5 QFN
SPDT, R	<a href="#">PE42723</a>	5	1794	–	39	38	0.1	0.4	34	54	2.3–5.5	35	3000	12L 3×3 QFN
SPDT, R	<a href="#">PE42724</a>	5	1794	–	39	38	0.1	0.4	19	39	2.3–5.5	35	2000	12L 3×3 QFN
SPDT, R	<a href="#">PE42726</a>	5	1794	–	39	38	0.1	0.4	19	39	2.3–5.5	38	2000	12L 3×3 QFN

**Note 1:** General-purpose, reflective 50Ω switches can also be used in a 75Ω environment.

**Note 2:** Absorptive (A) or reflective (R).

**Note 3:** 50% CTRL to 90% or 10% RF.

**Note 4:** Unpowered state: PE42742: RFC–RFI ON; PE42750: All ports terminated.

**Note 5:** P1dB levels.

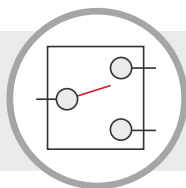

### Using 50Ω Switches in 75Ω Systems

Many 50Ω switches can be used in 75Ω systems. Scan the QR code to learn more



## 50Ω Broadband RF Switches

Our broadband 50Ω RF switches offer patented linearity technology enhancements that reduce gate lag and insertion loss drift, while maintaining high linearity and isolation over an extended frequency range up to 67 GHz.

Product Description <sup>1</sup>	Part Number	Operating Frequency (MHz)		IIP3/IIP2 (dBm)	Pmax CW (dBm)	PO.1dB (dBm)	Insertion Loss (dB)		Isolation (dB)		V <sub>DD</sub> Range (V)	Switching Time (μs) <sup>2</sup>	ESD HBM (V)	Package (mm)	
		Min	Max				Min	Max	Min	Max					
SPDT, A	<a href="#">PE42520</a>	0.009	13000	66/120	36	39	0.6	2.0	18	90	2.3-5.5	5.5	4000	16L 3×3 QFN	
SPDT, A	<a href="#">PE42521</a>	0.009	13000	65 / 120	36	38	0.6	1.85	17	90	2.3-5.5	0.5	3000	16L 3×3 QFN	
SPDT, A	<a href="#">PE42522</a>	0.009	26500	59 / 121	30	33	0.7	5.3	20	80	2.3-5.5	3	3500	29L 4×4 LGA	
SPDT, A	<a href="#">PE42553</a>	0.009	8000	66 / 120	36	39	0.6	0.85	36	90	2.3-5.5	5.5	4000	16L 3×3 QFN	
SPDT, R	<a href="#">PE42524</a>	10	40000	52 / -	27	32.5	0.6	5.5	33	84	-	0.225	2000	Flip Chip	
SPDT, R	<a href="#">PE42525</a>	0.009	60000	48 / 112	0.9	35	0.9	2.7	36	80	-	0.008	1000	Flip Chip	
SP4T, A	<a href="#">PE42540</a>	.00001	8000	58 / 100	30	33	0.7	1.2	27	84	3.0-3.6	5	2000	32L 5×5 LGA	
SP4T, A	<a href="#">PE42542</a>	0.009	18000	58 / 118	30	33	0.7	3.9	27	90	2.3-5.5	3	3500	29L 4×4 LGA	
SP4T, A	<a href="#">PE42543</a>	0.009	18000	59 / 113	30	33	0.7	4.1	29	90	2.3-5.5	0.5	2500	29L 4×4 LGA	
SP4T, R	<a href="#">PE42545</a>	0.009	67000	49	30	28	1	6.6	22.5	46	3.15-3.45	60 <sup>3</sup>	2000	Flip Chip	
SP4T, R	<a href="#">PE42546</a>	0.009	52000	48	29	27	1.1	3.8	23	41	3.15-3.45	60 <sup>3</sup>	2000	20L 3×3 LGA	
<b>NEW</b>	SP4T, R	<a href="#">PE42548<sup>4</sup></a>	0.009	30000	52	29	27	1.1	2.3	33	41	3.15-3.45	60	600 <sup>5</sup> 2000 <sup>6</sup>	20L 3×2 LGA
SP6T, A	<a href="#">PE42562</a>	0.009	8000	60 / 105	33	37.5	0.7	1.6	30	68	2.3-5.5	0.210	1000	24L 4×4 QFN	
SP8T, A	<a href="#">PE42582</a>	0.009	8000	60 / 105	33	37.5	0.7	1.6	30	85	2.3-5.5	0.227	1000	24L 4×4 QFN	
SP12T, A	<a href="#">PE42512</a>	0.009	8000	60 / 105	33	37.5	0.7	2.4	22	69	2.3-5.5	0.232	1000	32L 5×5 QFN	

**Note 1:** Absorptive (A) or reflective (R). **Note 2:** 50% CTRL to 90% or 10% RF. **Note 3:** Measured in ns. **Note 4:** Preliminary data. Visit our website for the latest information.

**Note 5:** ESD voltage HBM, all pins except RF. **Note 6:** ESD voltage HBM, RF pins.

## 50Ω High-power Switches

Our 50Ω high-power RF switches deliver a small footprint, monolithic, turnkey design with extremely low power consumption, excellent harmonic performance and high power handling.

Product Description <sup>1</sup>	Part Number	Operating Frequency (MHz)		IIP3 (dBm)	Pmax CW (dBm)	PO.1dB (dBm)	Insertion Loss (dB)		Isolation (dB)		V <sub>DD</sub> Range (V)	Switching Time (μs) <sup>2</sup>	ESD HBM (V)	Package (mm)
		Min	Max				Min	Max	Min	Max				
SPDT, A	<a href="#">PE42822</a>	700	3800	65	32	39.5	0.6	0.8	44	47	2.3-5.5	0.5	3000	16L 3×3 QFN
SPDT, R	<a href="#">PE42820</a>	30	2700	85	43	45.5	0.3	0.7	24	35	2.3-5.5	15	1500	32L 5×5 QFN
SPDT, R	<a href="#">PE42821</a>	100	2700	82	43	45.5	0.4	0.8	24	35	2.3-5.5	7	1500	32L 5×5 QFN
SPDT, R	<a href="#">PE42823<sup>3</sup></a>	700	6000	70	38.5	46	0.25	0.53	23	59	2.3-5.5	0.85	4500	16L 3×3 QFN
SP(3/5)T, R	<a href="#">PE42850</a>	30	1000	42	42.5	45.5	0.25	0.35	30	36	2.3-5.5	15	1500	32L 5×5 QFN
SP(3/5)T, R	<a href="#">PE42851</a>	100	1000	42	42.5	45.5	0.25	0.4	30	36	2.3-5.5	6	1500	32L 5×5 QFN
SP4T, R	<a href="#">PE42443</a>	1800	5000	85	50 <sup>4</sup>	50	0.33	.074	26	33	4.5-5.5	0.82	1000	20L 4×4 LGA
SP4T, R	<a href="#">PE42444</a>	1800	5000	85	50 <sup>4</sup>	50	.032	.068	25	38	4.5-5.5	0.86	1000	20L 4×4 LGA

**Note 1:** Absorptive (A) or reflective (R). **Note 2:** 50% CTRL to 90% or 10% RF. **Note 3:** RX protection switch. **Note 4:** Peak power with LTE modulation.

## Antenna Tuning Switches

Our antenna tuning switches offer industry-leading RF power handling and ruggedness along with best-in-class linearity in a small form factor.

Product Description*	Part Number	Operating Frequency (MHz)		RON ( $\Omega$ )	COFF (pF)	IMD3 (dBm)	Peak RF Voltage (Vpk)	Package (mm)
		Min	Max					
SPST, OR	<a href="#">PE613010</a>	10	3000	1.20	0.40	-115	25	10L 2x2 QFN
SP4T, OR	<a href="#">PE613050</a>	5	3000	1.60	0.14	-120	18	12L 2x2 QFN

Note: \* Open reflective (OR).

## Automotive Switches

Our AEC-Q100 Grade 2-certified automotive switches support operating temperatures up to +105 °C and a wide range of wireless applications such as automotive infotainment and traffic safety applications.

Product Description <sup>1</sup>	Part Number	Operating Frequency (MHz)		IIP3/IIP2 (dBm)	Pmax CW (dBm)	P0.1dB (dBm)	Insertion Loss (dB)		Isolation (dB)		V <sub>DD</sub> Range (V)	Switching Time ( $\mu$ s) <sup>2</sup>	ESD HBM (V)	Package (mm)
		Min	Max				Min	Max	Min	Max				
<b>NEW</b> SPDT, R	<a href="#">PE423211<sup>3</sup></a>	300	10600	–	25	25 <sup>4</sup>	0.3	0.6	15	30	2.7–3.6	0.1	2000	6L 1.6x1.6 DFN
SPDT, R	<a href="#">PE423422</a>	100	6000	73.5 / 115	32	34	0.25	0.9	16	41	2.3–5.5	2	1000	12L 2x2 QFN
SPDT, R	<a href="#">PE42359</a>	10	3000	55 / –	34	33.5	0.35	1.1	14	35	1.8–3.3	2	2000	6L SC70
SP4T, R	<a href="#">PE423641</a>	50	3000	68 / 115	35	37	0.5	0.95	22	32	2.65–3.3	1	2000	16L 3x3 QFN

Note 1: Reflective (R). Note 2: 50% CTRL to 90% or 10% RF. Note 3: Preliminary data. Visit our website for the latest information. Note 4: PIdB levels.

## Extended Temperature RF Switches

Our 50 $\Omega$  extended temperature switches are ideal for applications that require wide temperature range support from –55 °C to +125 °C, such as harsh industrial applications.

Product Description <sup>1</sup>	Part Number	Operating Frequency (MHz)		IIP3/IIP2 (dBm)	Pmax CW (dBm)	P0.1dB (dBm)	Insertion Loss (dB)		Isolation (dB)		V <sub>DD</sub> Range (V)	Switching Time ( $\mu$ s) <sup>2</sup>	ESD HBM (V)	Package (mm)
		Min	Max				Min	Max	Min	Max				
SPDT, R	<a href="#">PE426525</a>	0.009	60000	48 / 112	27	35	0.9	2.7	36	80	–	0.008	1000	Flip Chip
SP6T, A	<a href="#">PE426462</a>	10	8000	60 / 105	31	37.5	0.7	1.6	30	68	2.3–5.5	0.210	1000	24L 4x4 QFN
SP8T, A	<a href="#">PE426482</a>	10	8000	60 / 105	31	37.5	0.7	1.6	30	85	2.3–5.5	0.227	1000	24L 4x4 QFN
SPI2T, A	<a href="#">PE426412</a>	10	8000	60 / 105	31	37.5	0.7	2.4	22	69	2.3–5.5	0.232	1000	32L 5x5 QFN

Note 1: Absorptive (A) or reflective (R). Note 2: 50% CTRL to 90% or 10% RF.

# Attenuators

## Wired Broadband RF Digital Step Attenuators

Our 75Ω wired broadband RF digital step attenuators (DSAs) feature attenuation steps of 0.5 dB to 31.5 dB and low distortion for CATV and multi-carrier applications.

Visit our website  
to learn more



Part Number	Attenuation (dB) (Range/ Min. Step Size)	Programming Mode	Operating Frequency (MHz)		Insertion Loss (dB)		IIP3 (dBm)	Attenuation Accuracy (dB @ 1 GHz)	Switching Time (μs)	ESD HBM (V)	Package (mm)	Product Notes
			Min	Max	Min	Max						
<b>PE4314</b> <sup>1</sup>	0–31.5 / 0.5	Parallel <sup>2</sup> , Serial	1	2500	1	1.5	58	±(0.15 + 3% of setting)	370	1500	20L 4×4 QFN	6-bit
<b>PE43665</b>	0–31.5 / 0.5	Parallel <sup>2</sup> , Serial	1	2000	1.4	1.8	52	±(0.15 + 4% of setting)	1	500	20L 4×4 QFN	6-bit

**Note 1:** External  $V_{SS}$  option. **Note 2:** Parallel modes: latched and direct.

## Glitchless RF Digital Step Attenuators

Our 50Ω glitchless RF DSAs feature glitchless attenuation state transitions and an extended operating temperature range to +105 °C, ideal for many broadband wireless applications.

Part Number	Attenuation (dB) (Range/ Min. Step Size)	Programming Mode	Operating Frequency (MHz)		Insertion Loss (dB)		IIP3 (dBm)	Attenuation Accuracy (dB @ 2.2 GHz)	Switching Time (ns)	ESD HBM (V)	Package (mm)	Product Notes
			Min	Max	Min	Max						
<b>PE43711</b>	0–31.75 / 0.25	Parallel <sup>1</sup> , Serial	0.009	6000	1.3	2.4	57	±(0.15 + 1.5% of setting)	275	3000	24L 4×4 QFN	7-bit
<b>PE43712</b>	0–31.75 / 0.25	Parallel <sup>1</sup> , Ser-Add <sup>2</sup>	0.009	6000	1.3	2.45	57	±(0.20 + 1.5% of setting)	275	3000	32L 5×5 QFN	7-bit
<b>PE43713</b> <sup>3</sup>	0–31.75 / 0.25	Parallel <sup>1</sup> , Ser-Add <sup>2</sup>	0.009	6000	1.3	2.45	57	±(0.20 + 1.5% of setting)	275	3000	32L 5×5 QFN	7-bit

**Note 1:** Parallel modes: latched and direct. **Note 2:** Serial-addressable mode. **Note 3:** External  $V_{SS}$  option.

## General-purpose RF Digital Step Attenuators

Our 50Ω general-purpose RF DSAs feature high linearity, fast switching time with wide bandwidth, and best-in-class attenuation accuracy with fine attenuation steps.

Part Number	Attenuation (dB) (Range/ Min. Step Size)	Programming Mode	Operating Frequency (MHz)		Insertion Loss (dB)		IIP3 (dBm)	Attenuation Accuracy (dB @ 1 GHz)	Switching Time (μs)	ESD HBM (V)	Package (mm)	Product Notes
			Min	Max	Min	Max						
<b>PE43205</b> <sup>1</sup>	0–18 / 6	Parallel	35	6000	0.5	1.05	61	+0.10	0.031	2000	12L 3×3 QFN	2-bit
<b>PE43620</b>	0–18 / 6, 12, and 18	Parallel <sup>3</sup>	50	3000	0.6	0.7	61	±(-0.25/+0.40 of setting)	0.03	2000	12L 3×3 QFN	2-bit
<b>PE43650</b>	0–15.5 / 0.5	Parallel <sup>3</sup> , Serial	0.009	6000	2.4	2.9	58	±(0.3/+0.30 of setting)	4	500	24L 4×4 QFN	5-bit
<b>PE4312</b> <sup>2</sup>	0–31.5 / 0.5	Parallel <sup>3</sup> , Serial	1	4000	1.3	2.1	59	±(0.15 + 2% of setting)	0.5	1500	20L 4×4 QFN	6-bit
<b>PE43508</b> <sup>1,2</sup>	0–31.5 / 0.5	Par <sup>3</sup> , Ser, Ser-Add <sup>4</sup>	0.009	55000	2.2	5.9	50	+ (1.00+4.5% of setting) /-1	0.330	1000	Flip Chip	6-bit
<b>PE43610</b> <sup>1,2</sup>	0–31.5 / 0.5	Par <sup>3</sup> , Ser, Ser-Add <sup>4</sup>	0.009	13000	1.6	3	50	+ (1.00+4.5% of setting) /-1	0.330	1000	24L 4×4 LGA	6-bit
<b>PE43614</b> <sup>1,2</sup>	0–31.5 / 0.5	Par <sup>3</sup> , Ser, Ser-Add <sup>4</sup>	0.009	45000	3	5.8	50	+ (1.00+4.5% of setting) /-1	0.330	1000	24L 4×4 LGA	6-bit
<b>PE43670</b>	0–31.75 / 0.25	Parallel <sup>3</sup> , Ser-Add <sup>4</sup>	0.009	4000	1.9	2.4	59	±(0.2/+0.15 of setting)	4	500	32L 5×5 QFN	7-bit
<b>PE43704</b> <sup>2</sup>	0–31.75 / 0.25	Par <sup>3</sup> , Ser, Ser-Add <sup>4</sup>	0.009	8000	1.3	2.9	61	+ (0.15 + 4.5% of setting) -(0.1 + 2% of setting)	1.1	1500	32L 5×5 QFN	7-bit
<b>PE43705</b> <sup>1,2</sup>	0–31.75 / 0.25	Par <sup>3</sup> , Ser, Ser-Add <sup>4</sup>	50	8000	1.3	2.4	58	+ (0.15 + 1.5% of setting) -(0.1 + 1% of setting)	1	1500	32L 5×5 QFN	7-bit

**Note 1:** Operating temperature up to +105 °C. **Note 2:** Glitch-safe: negative glitch only. **Note 3:** Parallel modes: latched and direct. **Note 4:** Serial-addressable mode.

# Phase & Amplitude Control

## Phase Shifter

Our 50Ω digital phase shifter offers an ideal solution for optimizing transmission phase with its low RMS phase and amplitude error levels, and dual parallel and serial programming options.

Visit our [website](#) to learn more



Part Number	Operating Frequency (GHz)		Bit #	Range (deg)	Resolution (deg)	Insertion Loss (dB)	RMS Phase Error (deg)	RMS Amplitude Error (dB)	Settling Time (ns)	V <sub>DD</sub> Range (V)	ESD HBM (V)	Package (mm)
	Min	Max										
<b>PE44820*</b>	1.7	2.2	8	358.6	1.4	6	1.0	0.1	365	2.3–5.5	500	32L 5×5 QFN

Note: \* With extended frequency support from 1–3 GHz.

## Monolithic Phase & Amplitude Controllers (MPACs)

Our 50Ω MPACs provide an integrated solution for Doherty power amplifier optimization and offer reliable phase and amplitude control of two independent RF paths.

Part Number	Operating Frequency (GHz)		Phase (deg) (Range/Steps/Bits)	Attenuation (dB) (Range/Steps/Bits)	Programming Mode	Insertion Loss (dB)	IIP3 (dBm)	PO1dB (dBm)	V <sub>DD</sub> Range (V)	I <sub>DD</sub> (mA)	ESD HBM (V)	Package (mm)
	Min	Max										
<b>NEW</b> <b>PE44951*</b>	6.025	7.525	360 / 5.625 / 6	15.75 / 0.125 / 7	Serial	–	–	–	–	–	–	32L 5×5 LGA
<b>PE46120</b>	1.8	2.2	–87.2 / 2.8 / 5	7.5 / 0.5 / 4	Serial	6.9	60	35	2.3–5.5	350	1000	32L 6×6 QFN
<b>PE46130</b>	2.3	2.7	–87.2 / 2.8 / 5	7.5 / 0.5 / 4	Serial	7.2	70	35	2.3–5.5	350	1500	32L 6×6 QFN
<b>PE46140</b>	3.4	3.8	–87.2 / 2.8 / 5	7.5 / 0.5 / 4	Serial	6.5	60	35	2.3–5.5	350	1500	32L 6×6 QFN

Note: \* Preliminary data. Visit our website for the latest information.

## Digital Tunable Capacitors (DTCs)

Our DTCs continue a tradition of innovation, high performance and ease-of-use by offering wideband tuning coverage, minimum mismatch losses, excellent linearity and fast switching speed.

Part Number	Interface	Operating Frequency (MHz)		Min Shunt Capacitance (pF)	Max Shunt Capacitance (pF)	Tuning Ratio (Shunt)	Quality Factor (Shunt, 1 GHz)		Peak Operating Voltage (V <sub>PK</sub> )	V <sub>DD</sub> Range (V)	ESD HBM (V)	Package (mm)
		Min	Max				C <sub>min</sub>	C <sub>max</sub>				
<b>PE64102</b>	SPI	100	3000	1.88	14	7.4:1	50	28	6	2.3–3.6	2000	12L 2×2 QFN
<b>PE64904</b>	SPI	100	3000	1.10	5.10	4.6:1	35	10	30	2.3–3.6	1500	10L 2×2 QFN
<b>PE64906</b>	SPI	100	3000	0.90	4.60	5.1:1	40	40	30	2.3–4.8	2000	10L 2×2 QFN
<b>PE64907</b>	SPI	100	3000	0.85	2.40	2.82:1	41	37	30	2.3–4.8	2000	10L 2×2 QFN
<b>PE64909</b>	SPI	100	3000	0.60	2.35	3.9:1	40	40	30	2.3–4.8	2000	10L 2×2 QFN

# Front-end Modules

## 2.4 GHz IoT FEM

The PE562212, built around the fast adoption of the Matter standard, enables connectivity across Thread, Zigbee, Bluetooth BDR/EDR, BLE, and low-medium throughput Wi-Fi (MCS7) as well as 2.4 GHz proprietary applications.

Part Number*	Frequency (MHz)		P1.0dB (dBm)	P <sub>SAT</sub> (dBm)	Tx Gain (dB)	Tx Gain Control (dB)	Tx Gain Step (dB)	Rx NF (dB)	Rx Gain (dB)	Bypass Loss (dB)	Supply Voltage (V)	Package (mm)
	Min	Max										
<b>NEW</b> <a href="#">PE562212</a>	2400	2483.5	21	24	23	15	1	1.6	15	-0.6	3.0-3.6	14-lead 1.8x1.8 LGA

Note: \* Preliminary data. Visit our website for the latest information.

Visit our [website](#) to learn more



## Tx/Rx Modules

### Beamforming Front End

Our 8-channel beamforming front-end solution integrates power amplifiers, low-noise amplifiers, phase shifters and switches into a single die that provides optimal signal strength for up to 1024-element antenna arrays.

Part Number	Operating Frequency (GHz)		Package (mm)	Product Note
	Min	Max		
<a href="#">PE188200</a>	26.5	29.5	Flip Chip	n257 mmWave FEM

Visit our [website](#) to learn more



## Integrated Products

### Switch + LNA Module

pSemi's dual-channel switch + LNA module incorporates high-power fail-safe switches and low-noise amplifiers with a bypass function. This receiver front-end module features low noise, excellent linearity and very low power consumption in a compact size and is ideally suited to 5G mMIMO applications.

Part Number	Operating Frequency (MHz)		OIP3 (dBm)	P <sub>max</sub> Avg (dBm)	Noise Figure (dB)	Isolation (dB, typ)	V <sub>DD</sub> Range (V)	Switching Time (μs)*	Package (mm)
<a href="#">PE53231</a>	3300	4200	32	43	0.9	47	4.75-5.25	0.5	40L 6x6 LGA

Note \*: 50% CTRL to 90% or 10% R.

# Mixers & Limiters

## Power Limiters

With both limiting and reflecting modes, our power limiters are highly integrated and smaller than PIN diode solutions; they feature an adjustable threshold control, high-power handling and fast response and recovery times.

Visit our [website](#) to learn more



Part Number	Operating Frequency	Adjustable Power Limiting Threshold (dBm)	Max Power Handling (dBm)		IIP3 (dBm)	Control Voltage Range (V)*	ESD HBM (V)	Package (mm)	Product Notes
			Pulsed	CW					
<a href="#">PE45361</a>	10 MHz–8 GHz	7–13	50	36	37	0 to 0.3	7000	12L 3×3 QFN	Low Threshold
<a href="#">PE45450</a>	9 kHz–6 GHz	25–35	47	40	70	–2.5 to –0.5	8000	12L 3×3 QFN	Broadband

Note: \* Limiting mode.

## Up-Down Converter

Our dual-channel mmWave up-down converter is a highly integrated, ultra-wideband solution that delivers low power consumption, optimal I/Q balance and minimal LO leakage to active antenna designs.

Part Number	Operating Frequency (GHz)		Package (mm)	Product Note
	Min	Max		
<a href="#">PE128300</a>	24.25	29.5	Flip Chip	n258 and n257

## Prescaler

Our prescaler offers low-phase noise performance and low-power consumption with high-frequency support up to 13.5 GHz for a wide variety of compact high-performance applications.

Part Number	Divide Ratio	Operating Frequency (MHz)		ESD HBM (V)	Package (mm)
		Min	Max		
<a href="#">PE35400</a>	Divide by 4	3000	13500	250	Die

## Mixers

Our UltraCMOS mixers apply quad MOSFET array cores to deliver high linearity and isolation, low conversion loss and easier implementation than GaAs-based MOSFET arrays.

Part Number	Operating Frequency (MHz)			LO Drive (dBm)	Conv Loss (dB)	Isolation (dB, typ)		IIP3 (dBm)	ESD HBM (V)	Package (mm)
	LO	RF	IF, Nom			LO–RF	LO–IF			
<a href="#">PE4140</a> <sup>1,2</sup>	0.01–6000	0.01–6000	0.01–6000	0 to +20	6.5–7.5	25–40	25–40	32	100	6L 3×3 DFN
<a href="#">PE4141</a> <sup>1,2,3</sup>	0.01–1000	0.01–1000	0.01–1000	0 to +20	7.0–8.0	40	40	33	100	8L MSOP
<a href="#">PE4151</a> <sup>1,3</sup>	245–410	136–520	44.85–109.65	–10 to –6	6.5–8.5	43	40	26	1000	10L MSOP
<a href="#">PE4152</a> <sup>1</sup>	245–831	136–941	109.65	–10 to +23	6.5–7.5	30–60	22–58	26	1000	20L 4×4 QFN

Note 1: Fully differential DC coupled ports. External baluns required. Note 2: Quad MOSFET array. Note 3: Low magnetic.



# UltraCMOS® Technology

## Silicon-on-Insulator Innovation

UltraCMOS technology — a patented, advanced form of silicon-on-insulator (SOI) — enables pSemi to offer a market-leading combination of large- and small-signal performance.

With its outstanding RF and microwave properties, SOI provides an ideal substrate for integration. When paired with high-volume CMOS — the most widely-used semiconductor technology — the result is a reliable, repeatable technology platform that offers superior performance compared to other mixed-signal processes.

UltraCMOS products allow engineers the flexibility to prioritize attributes — like small form factor, low power consumption, high reliability, radiation tolerance, high ESD ratings, programmability, affordability, reduced board area — based on use case.

## Intelligent Integration

UltraCMOS products feature intelligent integration — the ability to integrate RF, digital and analog components on a single die.

With intelligent integration, a single chip can integrate features such as RF amplifiers, analog DC tracking, digital logic control, high-performance switching, phase shifters and digital step attenuators.

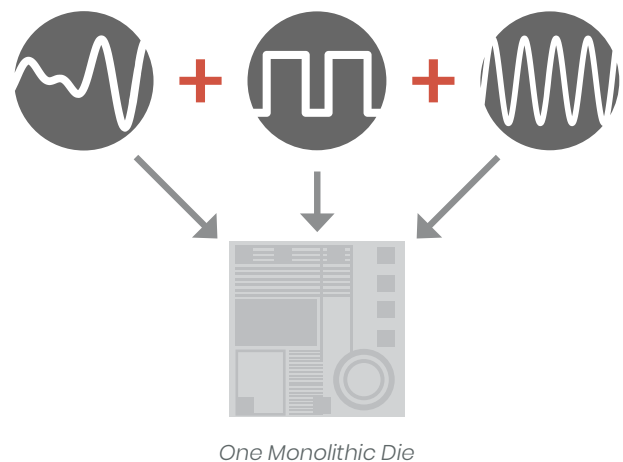

- ✓ Flexibility
- ✓ Reliability
- ✓ Configurability
- ✓ Repeatability
- ✓ Smaller Footprint
- ✓ Ease-of-Use

## HaRP™ Technology

UltraCMOS technology uses stacked field effect transistors (FETs) manufactured on an insulating substrate, providing the ability to pass high-power RF signals. The HaRP invention allows for very linear FETs that, when stacked together, provide excellent linear performance.

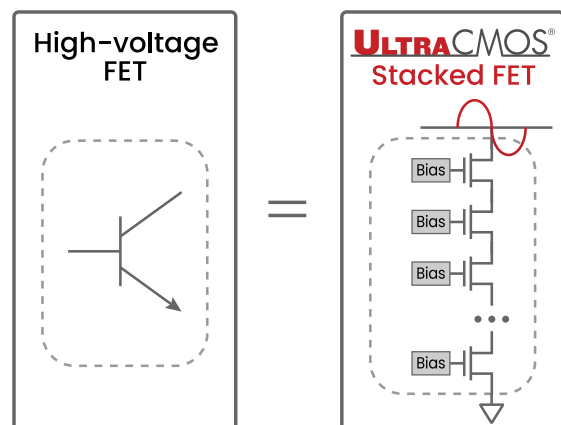

# High-performance RF Products

## Design Choice & Flexibility

RF complexity is growing exponentially as more wireless devices compete for signals throughout more frequency bands, and our products continue to achieve several SOI industry firsts that offer RF engineers the widest range of high-performance RF choices.

UltraCMOS products allow engineers the flexibility to prioritize attributes—like small form factor, low power consumption, high reliability, radiation tolerance, high ESD ratings, programmability, affordability, reduced board area—based on use case.

### Linearity Figure of Merit: P0.1dB

An UltraCMOS switch exhibits close to ideal linearity behavior up to the input 0.1dB compression point (P0.1dB), which remains invariant over power supply voltages.

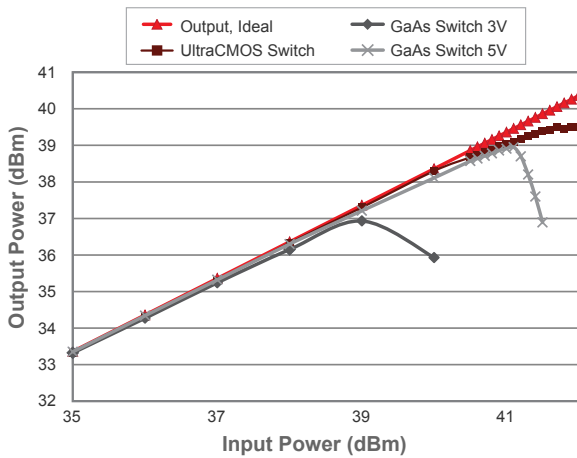

UltraCMOS switches do not compress in the same manner as switches on other technology processes, and a traditional P1dB measurement cannot be performed. Because UltraCMOS switch linearity is defined by the power handling capabilities of each switch, the P0.1dB compression point (derived from  $P_{MAX}$ ) is used as the figure of merit to reflect each switch's true linearity performance.

### Industry-leading Linearity Performance

PE42723 second and third harmonics (PIN = 65 dBmV)

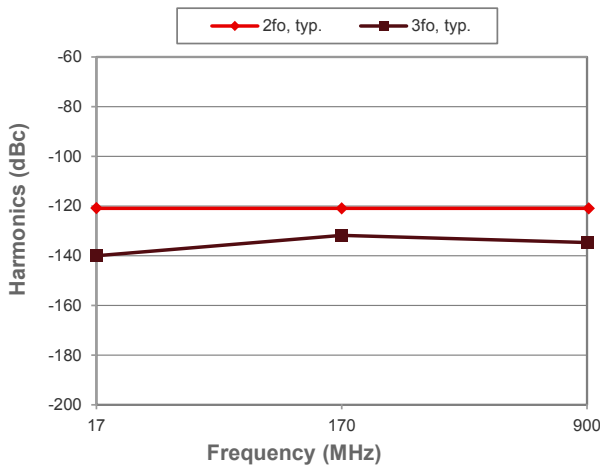

The PE42723 SPDT RF switch for DOCSIS 3.1/3.0 features unmatched linearity performance enabled by UltraCMOS technology, the only technology capable of addressing the linearity challenges of the future.

# Quality & Reliability

Our ISO9001:2015 and AS9100D certified quality systems, advanced designs, progressive process technology and excellent product performance enable us to consistently deliver high-quality, reliable products to customers.

## pSemi Quality Policy

pSemi is committed to providing quality products and services that meet or exceed customers' requirements the first time, every time, by:

- ✓ Fully understanding customers' requirements and expectations
- ✓ Providing products utilizing proven designs and manufacturing processes
- ✓ Developing a highly trained workforce that is motivated, empowered and fully accountable
- ✓ Establishing strong relationships with world-class suppliers
- ✓ Continually improving the efficiency and effectiveness of business processes and quality management systems

## Packaging

pSemi offers a variety of RoHS-compliant commercial packaging options. The images below illustrate basic package types we offer.

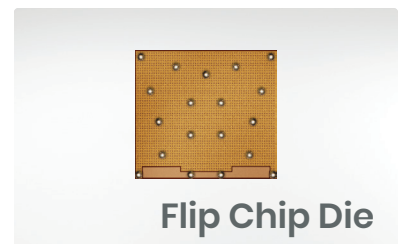
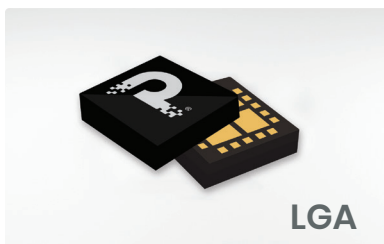



9369 Carroll Park Drive  
San Diego, CA 92121 USA  
+1-858-731-9400  
Sales@psemi.com

©2024 pSemi Corporation. All rights reserved.

The pSemi name, pSemi logo, and UltraCMOS are registered trademarks of pSemi Corporation. HaRP is a trademark of pSemi Corporation in the U.S. and other countries.

All other trademarks are the property of their respective owners. All information on these pages are subject to change without notice. Consult website for latest specifications. pSemi products are protected under one or more of the following U.S. patents: <http://patents.psemi.com>.

DOC-94007-21 Web Version 07/2024

**pSemi.com**

