

PE42822

Document Category: Product Specification

UltraCMOS® SPDT RF Switch, 700 MHz–3.8 GHz



Features

- Excellent single-event peak power handling of 46.1 dBm LTE
- Exceptional linearity performance across all frequencies
 - Input IP3: 65 dBm
 - Input IP2: 120 dBm
- Extended operating temperature of +105 °C
- 1.8V/3.3V TTL compatible control
- High ESD performance of 3 kV HBM on RF pins to ground
- Packaging – 16-lead 3 × 3 × 0.85 mm QFN

Applications

- Wireless infrastructure
- Receiver protection switch

Figure 1 • PE42822 Functional Diagram

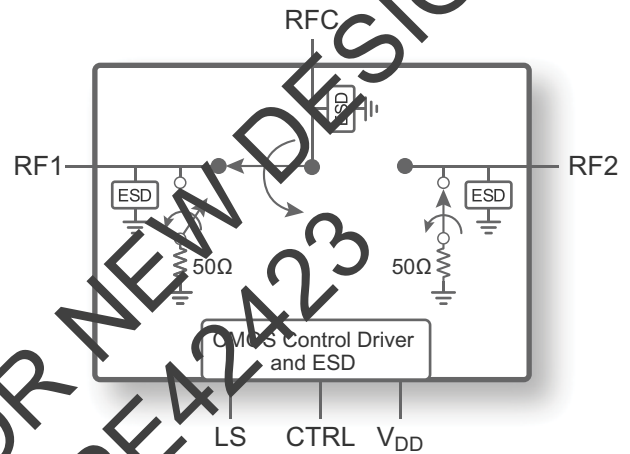

Product Description

The PE42822 is a HaRP™ technology-enhanced absorptive 50Ω SPDT RF protection switch designed for use in high power and high performance wireless infrastructure applications such as a mid-power microcell products, supporting frequencies up to 3.8 GHz.

This switch features high linearity, which remains invariant across the full supply range. The PE42822 also features exceptional isolation, fast switching time and is offered in a 16-lead 3 × 3 × 0.85 mm QFN package. In addition, no external blocking capacitors are required if 0 VDC is present on the RF ports.

The PE42822 is manufactured on Peregrine's UltraCMOS® process, a patented variation of silicon-on-insulator (SOI) technology on a sapphire substrate.

Peregrine's HaRP technology enhancements deliver high linearity and excellent harmonics performance. It is an innovative feature of the UltraCMOS process, offering the performance of GaAs with the economy and integration of conventional CMOS.

Absolute Maximum Ratings

Exceeding absolute maximum ratings listed in **Table 1** may cause permanent damage. Operation should be restricted to the limits in **Table 2**. Operation between operating range maximum and absolute maximum for extended periods may reduce reliability.

ESD Precautions

When handling this UltraCMOS device, observe the same precautions as with any other ESD-sensitive devices. Although this device contains circuitry to protect it from damage due to ESD, precautions should be taken to avoid exceeding the rating specified in **Table 1**.

Latch-up Immunity

Unlike conventional CMOS devices, UltraCMOS devices are immune to latch-up.

Table 1 • Absolute Maximum Ratings for PE42822

| Parameter/Condition | Min | Max | Unit |
|--|------|--------------|--------|
| Supply voltage, V_{DD} | -0.3 | 5.5 | V |
| Digital input voltage, V_{CTRL} | -0.3 | 3.6 | V |
| LS input voltage | -0.3 | 3.6 | V |
| Maximum input power, $P_{PK}^{(1)}$ 700–3800 MHz | | 46.1 | dBm |
| Storage temperature range | -65 | +150 | °C |
| ESD voltage HBM ⁽²⁾ RF pins to GND All pins | | 3000 1500 | V V |
| ESD voltage MM ⁽³⁾ , all pins | | 200 | V |
| ESD voltage, CDM ⁽⁴⁾ , all pins | | 1000 | V |
| Notes: 1) Max 5 cycles at 10 seconds duration each cycle, $P_{PK} = 46.1$ dBm, $P_{AV} = 38.1$ dBm, 8 dB PAR LTE signal. All other parameters within recommended operating conditions. No power applied to off-terminated port. No hot switching. 2) Human body model (MIL STD 883 Method 3015). 3) Machine model (JEDEC JESD22 A115). 4) Charged device model (JEDEC JESD22-C101). | | | |

Recommended Operating Conditions

Table 2 lists the recommended operating conditions for the PE42822. Devices should not be operated outside the recommended operating conditions listed below.

Table 2 • Recommended Operating Conditions for PE42822

| Parameter | Min | Typ | Max | Unit |
|--|------|-----|------------------|-----------------------|
| Supply voltage, V_{DD} | 2.3 | | 5.5 | V |
| Supply current, I_{DD} | | 120 | 200 | μ A |
| Digital input high | 1.17 | | 3.6 | V |
| Digital input low | -0.3 | | 0.6 | V |
| RF input power, single event ⁽¹⁾ 700–3800 MHz, peak 700–3800 MHz, average | | | 46.1 38.1 | dBm dBm |
| RF input power 700–3800 MHz, pulsed, +25 °C ⁽²⁾ 700–3800 MHz, pulsed, +105 °C ⁽²⁾ 700–3800 MHz, CW, -40 °C to +105 °C | | | 38.5 38 32 | dBm dBm dBm |
| RF input power into terminated ports, CW | | | 24 | dBm |
| Operating temperature range | -40 | +25 | +105 | °C |
| Notes: | | | | |
| 1) Single event: 10-second duration with 8 dB PAR LTE signal. No power applied to off-terminated port. No hot switching. | | | | |
| 2) 2.5% duty cycle of 4620 μ s period. No power applied to off-terminated port. No hot switching. | | | | |

NOT RECOMMENDED FOR NEW DESIGNS
REPLACE WITH PE42423

Electrical Specifications

Table 3 provides the PE42822 key electrical specifications @ +25 °C, $V_{DD} = 2.3\text{--}5.5\text{V}$, unless otherwise specified.

Table 3 • PE42822 Electrical Specifications

| Parameter | Path | Condition | Min | Typ | Max | Unit |
|--|---------|--|-----|------|------|------|
| Operational frequency | | | 700 | | 3800 | MHz |
| Insertion loss | RFC–RFX | 700–3800 MHz | | 0.8 | 1.05 | dB |
| Isolation | RFX–RFX | 700–3800 MHz | 44 | 46 | | dB |
| Isolation | RFC–RFX | 700–3800 MHz | 39 | 41 | | dB |
| Return loss (common and active port) | RFX | 700–3800 MHz | | 19 | | dB |
| Input 0.1dB compression point ^(*) | RFC–RFX | 700–3800 MHz | | 39.5 | | dBm |
| Input IP3 | RFC–RFX | 700–3800 MHz | | 65 | | dBm |
| Input IP2 | RFC–RFX | 700–3800 MHz | | 120 | | dBm |
| Switching time | | 50% CTRE to 90% or 10% of final value | | 500 | 700 | ns |
| Settling time | | 50% CTRE to 0.05 dB final value, rising and falling edge | | 2 | 4 | μs |

Note: * The input P0.1dB compression point is a linearity figure of merit. Refer to Table 2 for the operating RF input power (50Ω).

NOT RECOMMENDED FOR NEW DESIGNS
REPLACE WITH PE42423

Table 4 provides the PE42822 key electrical specifications @ +105 °C, $V_{DD} = 2.3\text{--}5.5\text{V}$, unless otherwise specified.

Table 4 • PE42822 Electrical Specifications

| Parameter | Path | Condition | Min | Typ | Max | Unit |
|--|---------|--|-----|------|------|------|
| Operational frequency | | | 700 | | 3800 | MHz |
| Insertion loss | RFC–RFX | 700–3800 MHz | | 0.95 | 1.2 | dB |
| Isolation | RFX–RFX | 700–3800 MHz | 44 | 46 | | dB |
| Isolation | RFC–RFX | 700–3800 MHz | 39 | 41 | | dB |
| Return loss (common and active port) | RFX | 700–3800 MHz | | 19 | | dB |
| Input 0.1dB compression point ^(*) | RFC–RFX | 700–3800 MHz | | 38.7 | | dBm |
| Input IP3 | RFC–RFX | 700–3800 MHz | | 65 | | dBm |
| Input IP2 | RFC–RFX | 700–3800 MHz | | 120 | | dBm |
| Switching time | | 50% CTRL to 90% or 10% of final value | | 500 | 700 | ns |
| Settling time | | 50% CTRL to 0.05 dB final value, rising and falling edge | | 2 | 4 | μs |

Note: * The input P0.1dB compression point is a linearity figure of merit. Refer to Table 2 for the operating RF input power (50Ω).

Control Logic

Table 5 provides the control logic truth table for the PE42822.

Table 5 • Truth Table for PE42822

| LS | CTRL | RFC–RF1 | RFC–RF2 |
|----|------|---------|---------|
| 0 | 0 | OFF | ON |
| 0 | 1 | ON | OFF |
| 1 | 0 | ON | OFF |
| 1 | 1 | OFF | ON |

Typical Performance Data

Figure 2–Figure 25 show the typical performance data @ +25 °C, $V_{DD} = 2.3\text{--}5.5\text{V}$, unless otherwise specified.

Figure 2 • Insertion Loss vs Temp (RF1)

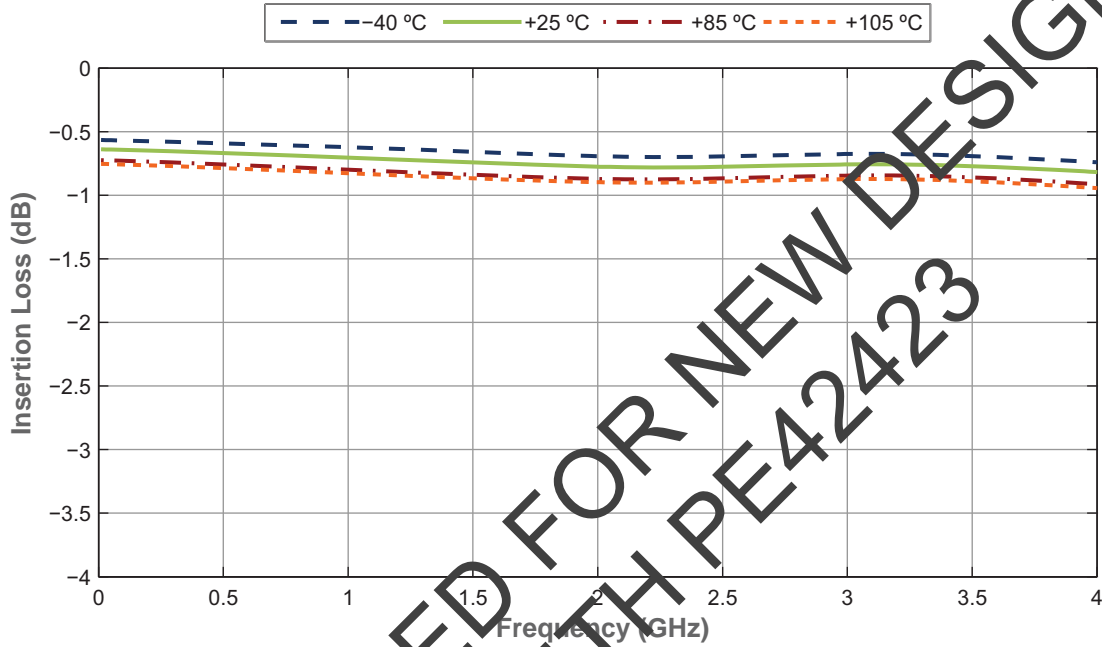

Figure 3 • Insertion Loss vs V_{DD} (RF1)

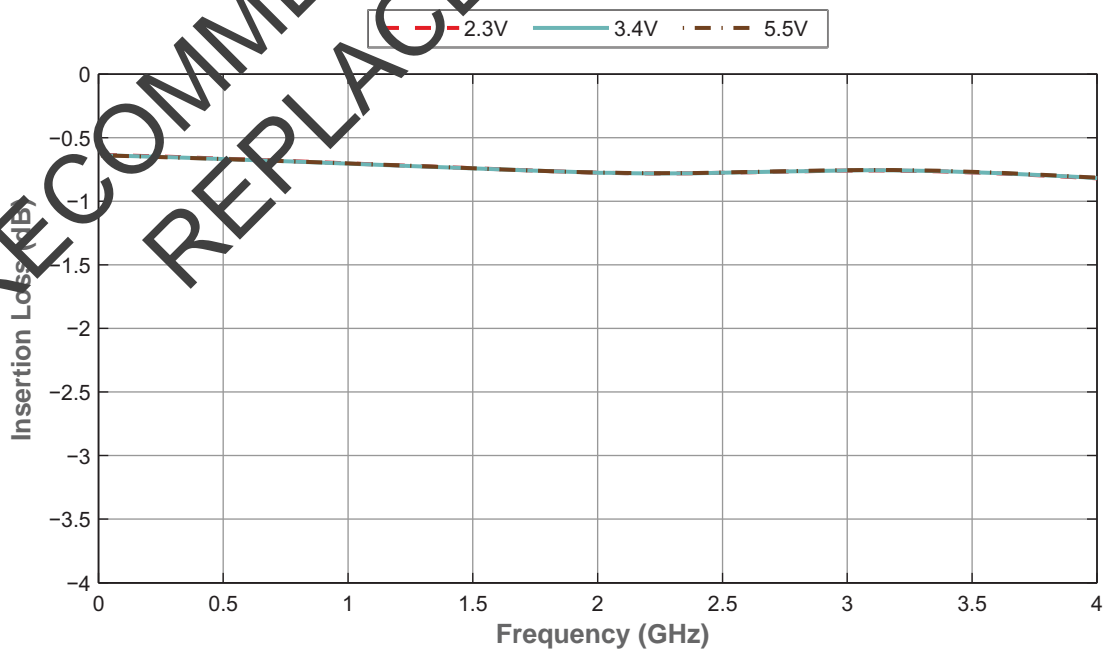

Figure 4 • Insertion Loss vs Temp (RF2)

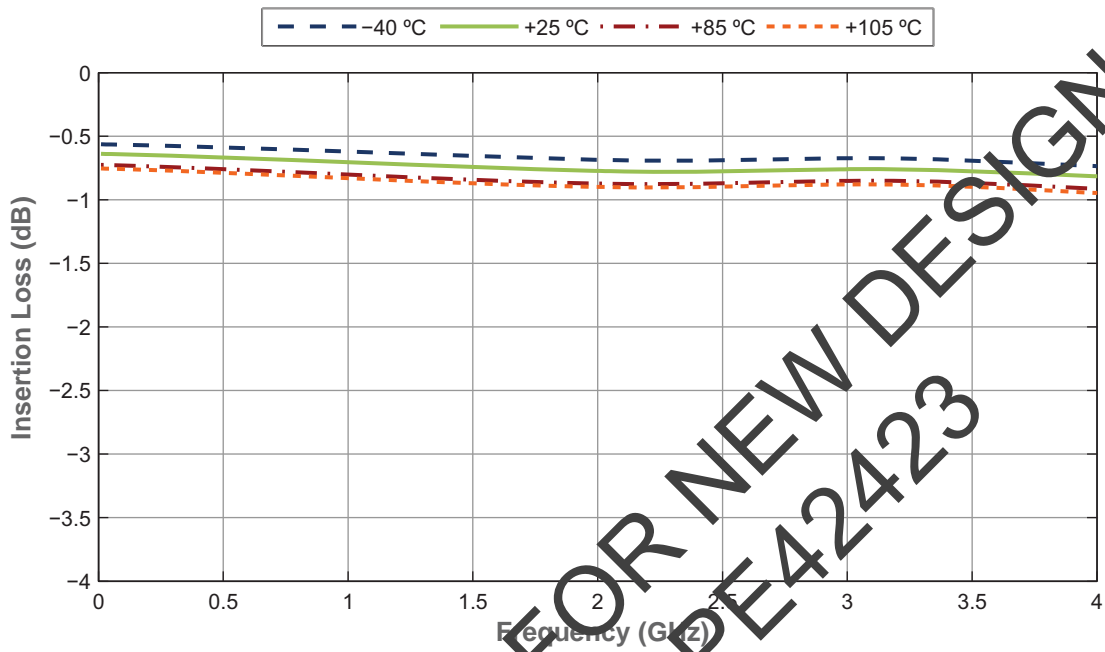
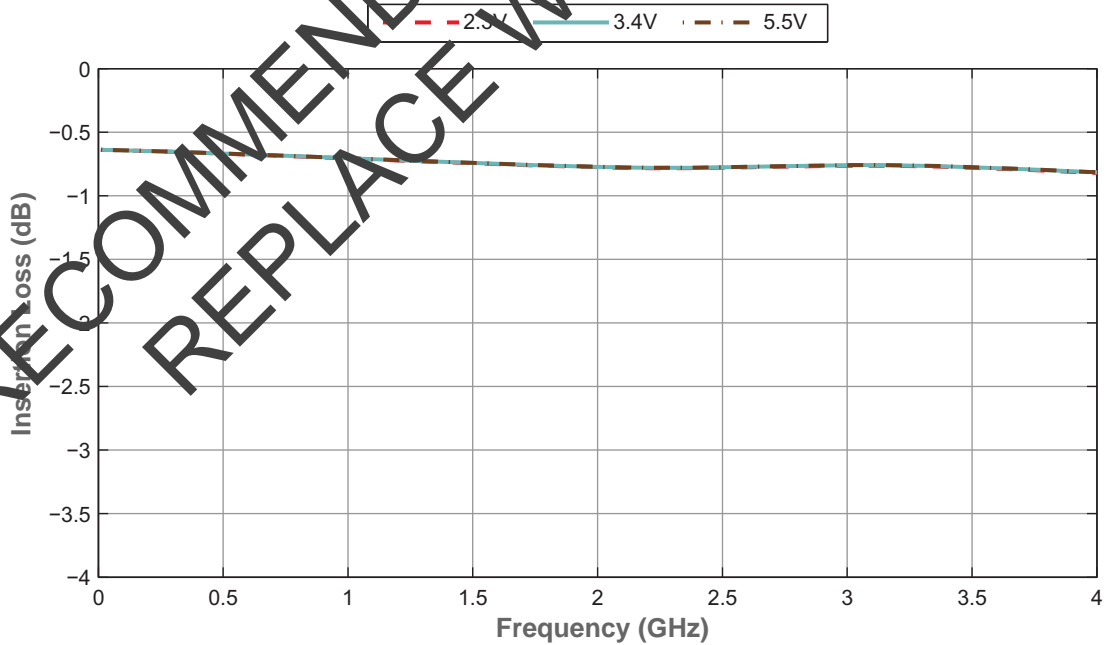

Figure 5 • Insertion Loss vs V_{DD} (RF2)



NOT RECOMMENDED FOR NEW DESIGNS
REPLACE WITH PE42423

Figure 6 • RFC Port Return Loss vs Temp (RF1)

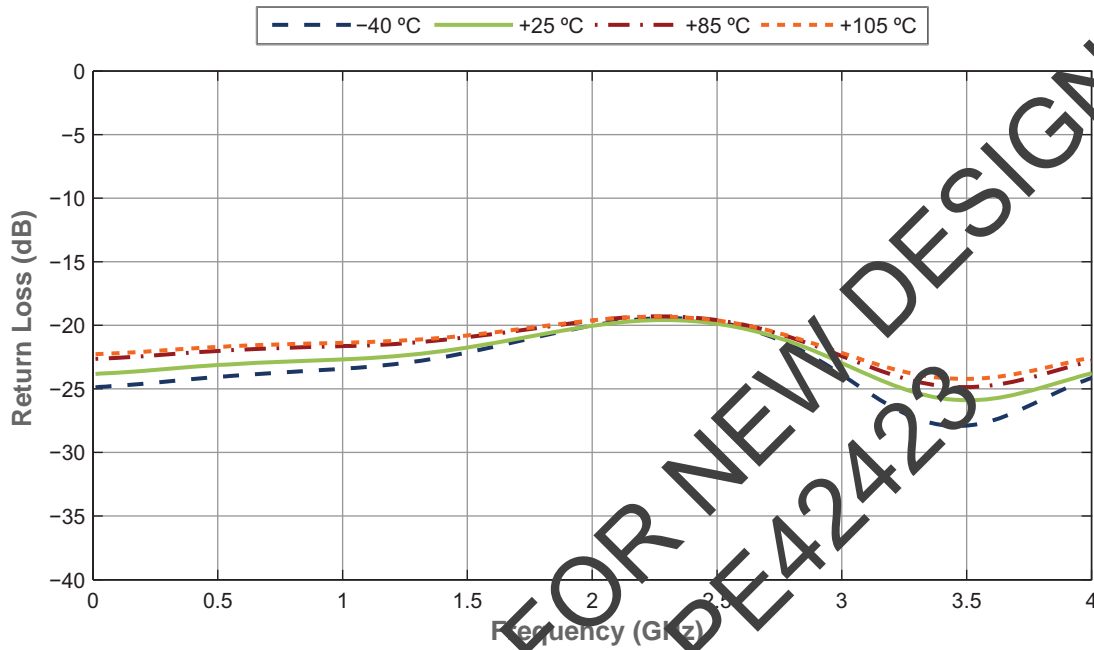
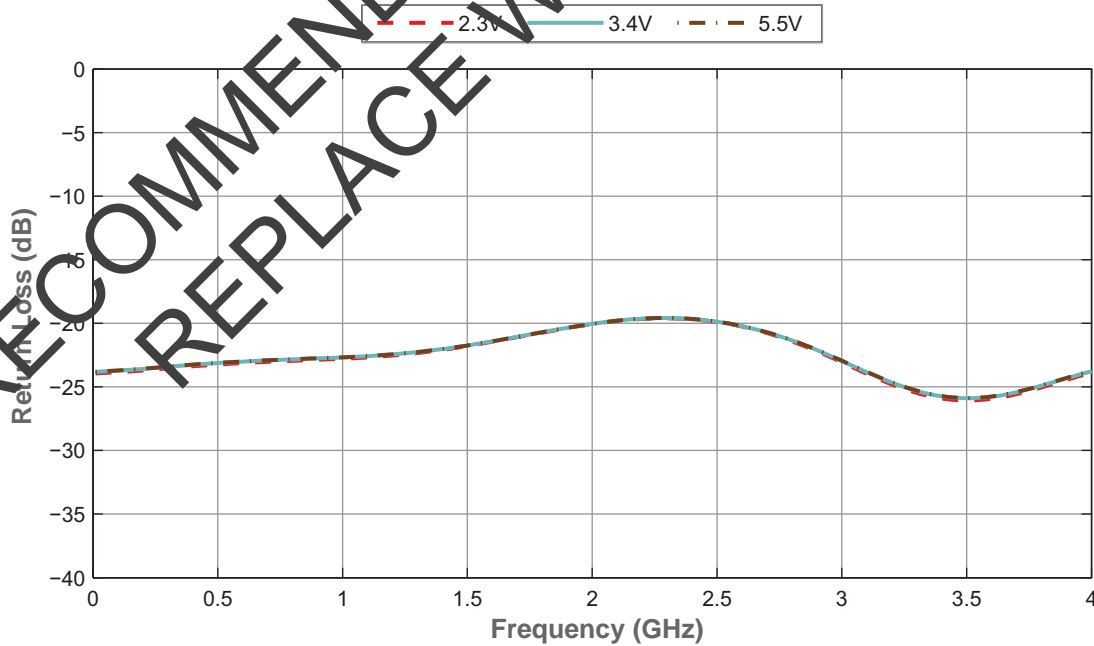

Figure 7 • RFC Port Return Loss vs V_{DD} (RF1)



NOT RECOMMENDED FOR NEW DESIGNS
REPLACE WITH PE42423

Figure 8 • RFC Port Return Loss vs Temp (RF2)

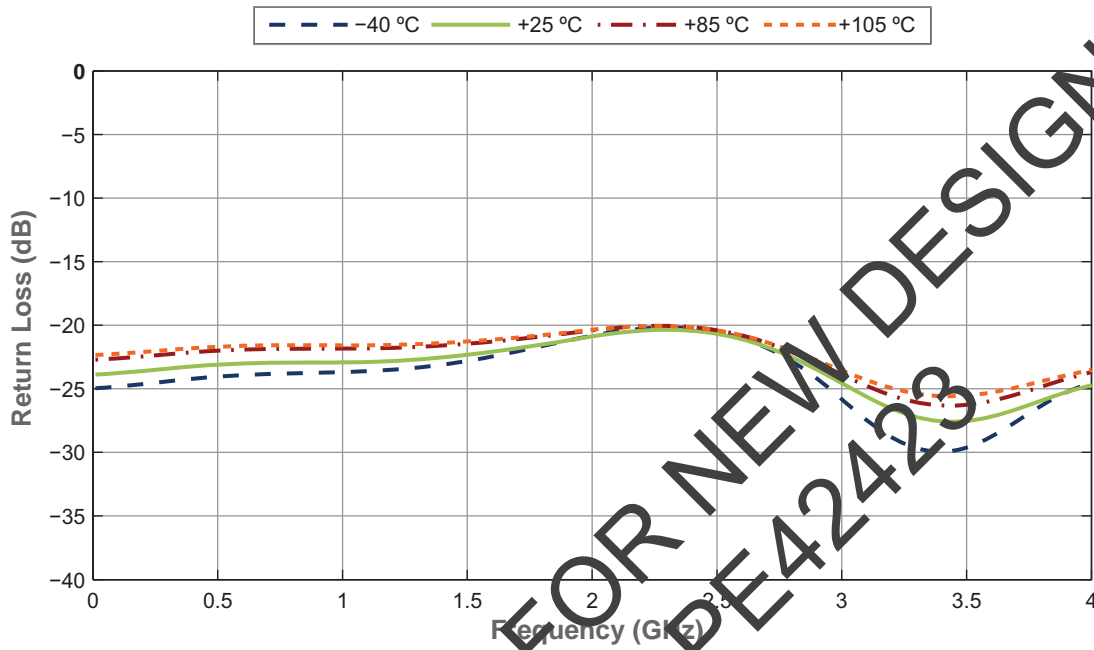
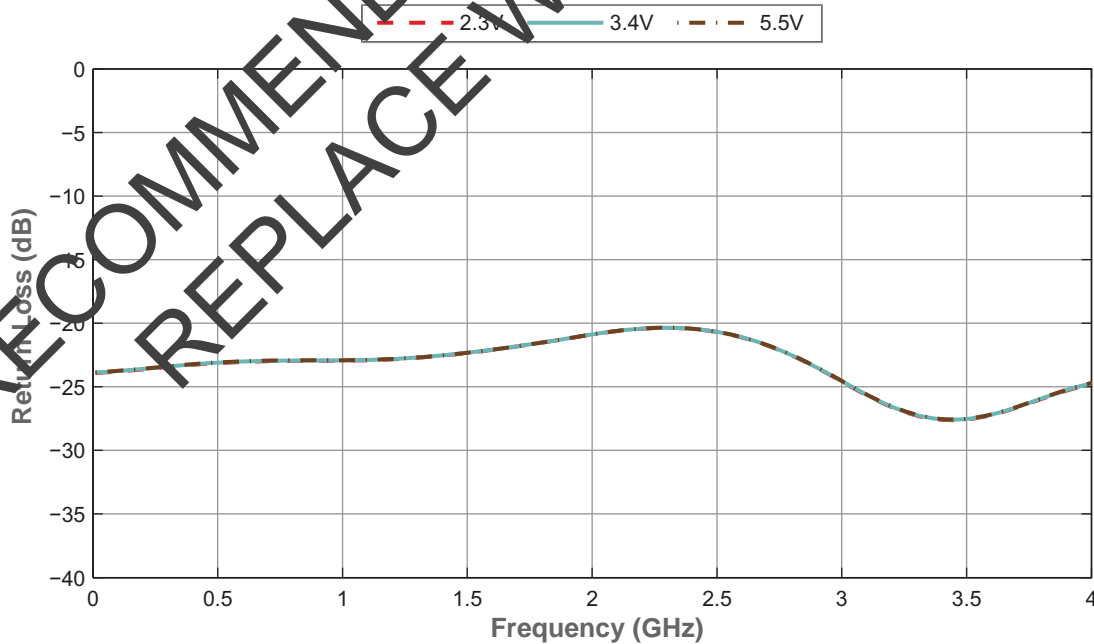

Figure 9 • RFC Port Return Loss vs V_{DD} (RF2)



NOT RECOMMENDED FOR NEW DESIGNS
REPLACE WITH PE42423

Figure 10 • Active Port Return Loss vs Temp (RF1)

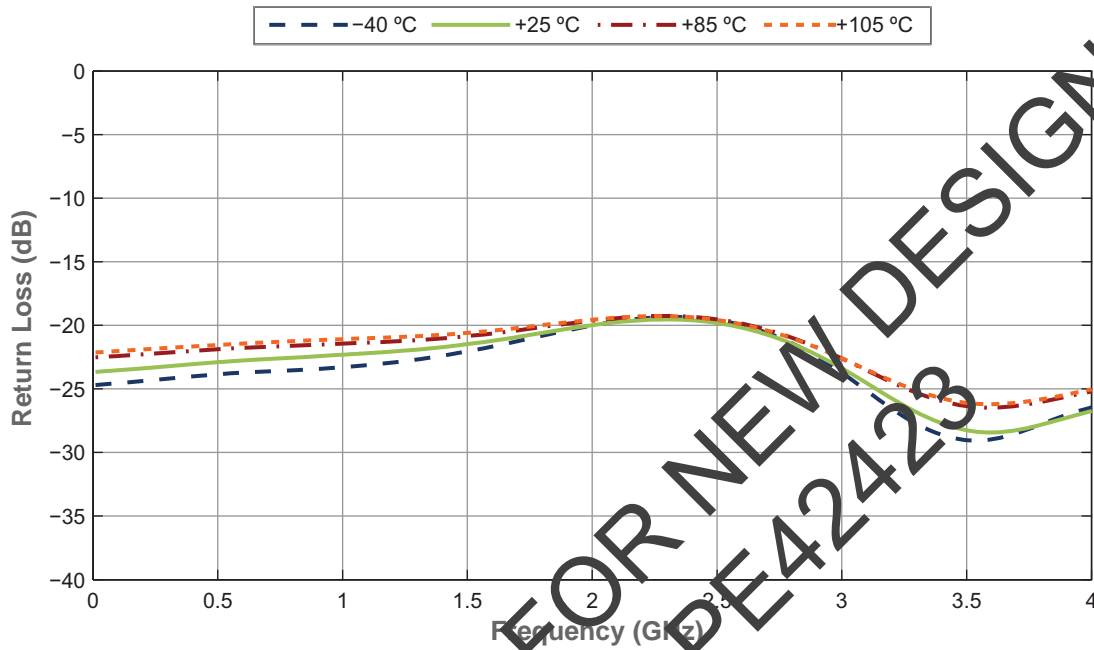
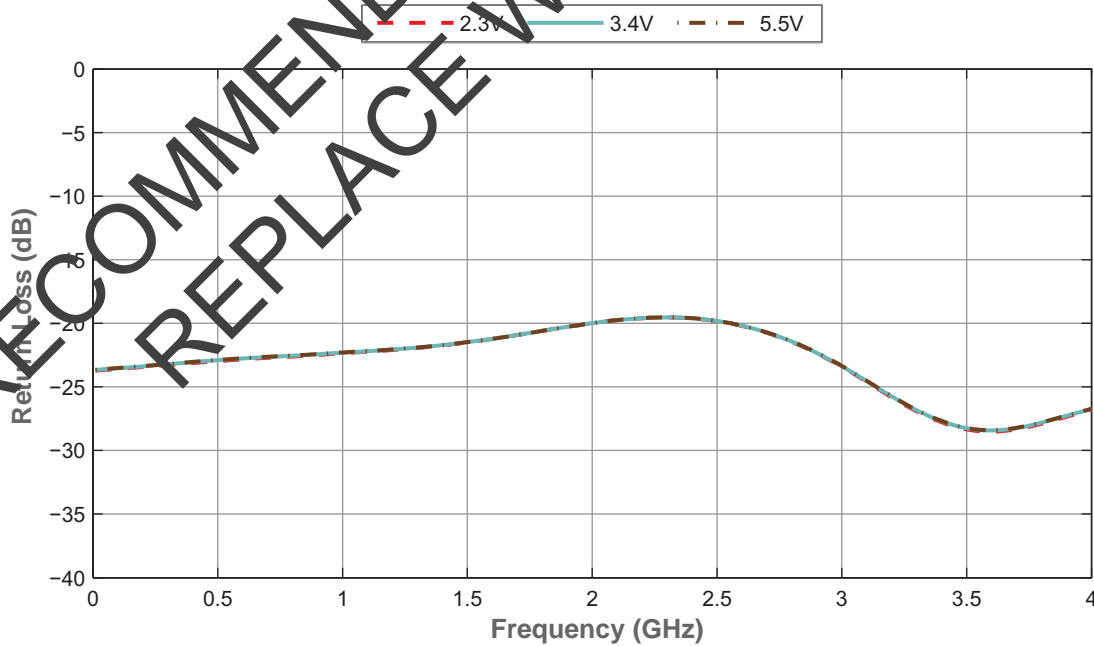

Figure 11 • Active Port Return Loss vs V_{DD} (RF1)



NOT RECOMMENDED FOR NEW DESIGNS
REPLACE WITH PE42423

Figure 12 • RFC Port Return Loss vs Temp (RF2)

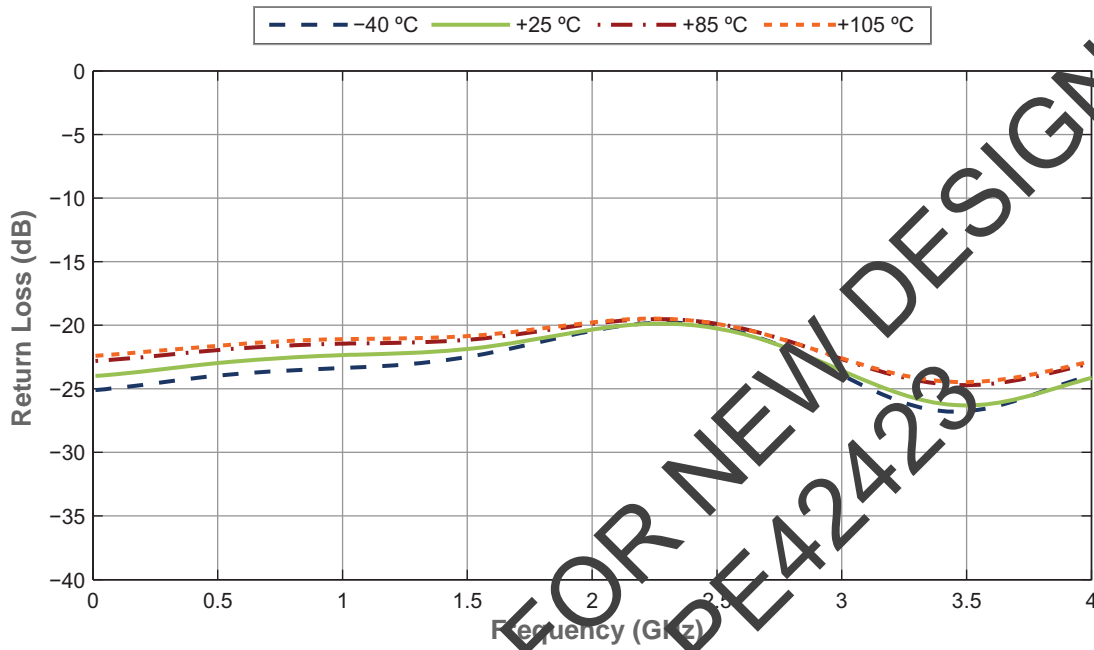
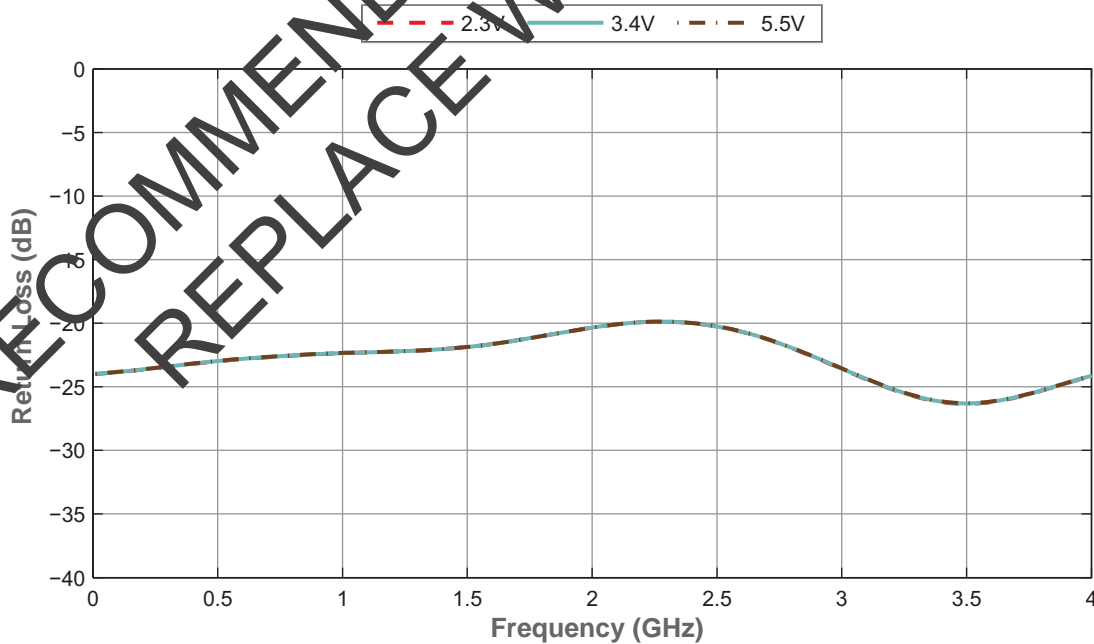

Figure 13 • RFC Port Return Loss vs V_{DD} (RF2)



NOT RECOMMENDED FOR NEW DESIGNS
REPLACE WITH PE42423

Figure 14 • Terminated Port Return Loss vs Temp (RF1)

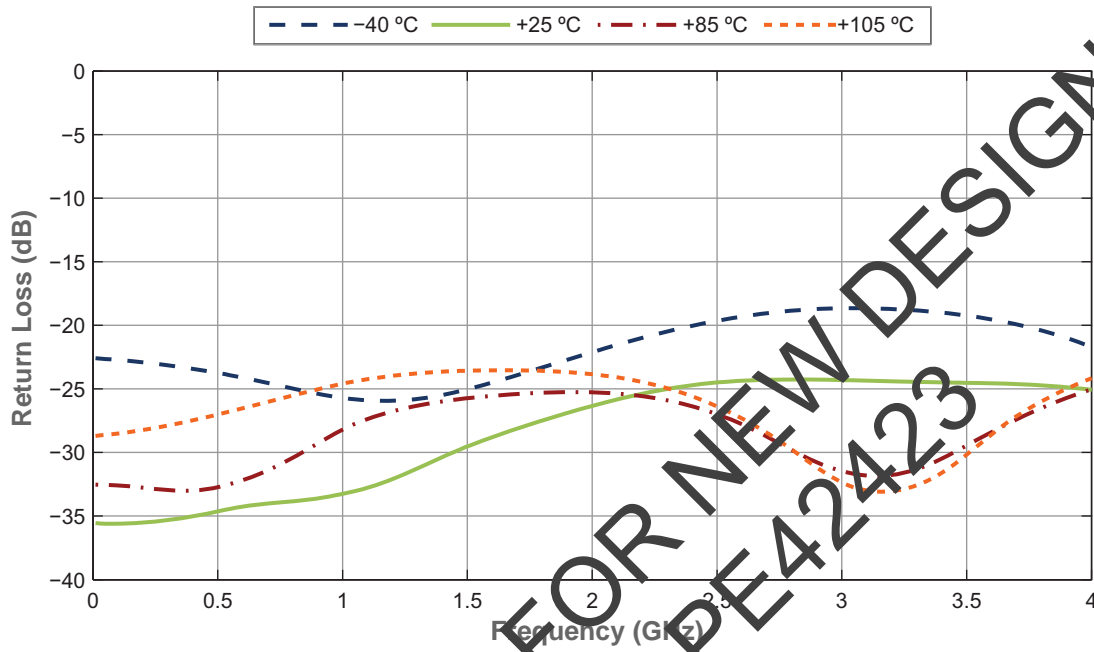
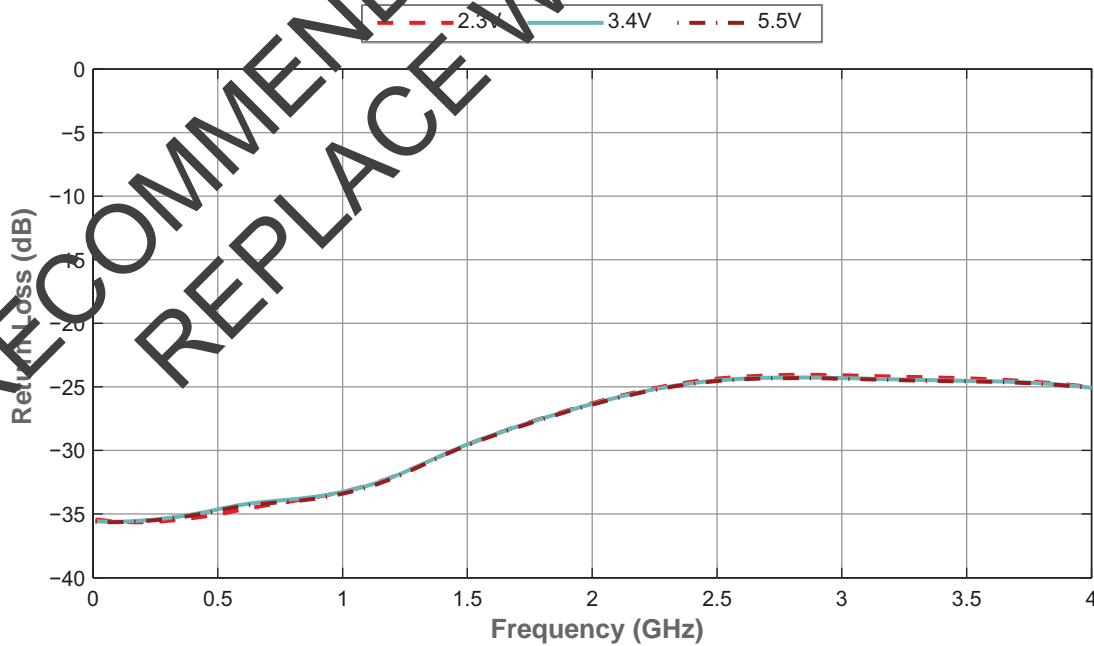

Figure 15 • Terminated Port Return Loss vs V_{DD} (RF1)



NOT RECOMMENDED FOR NEW DESIGNS
REPLACE WITH PE42423

Figure 16 • Terminated Port Return Loss vs Temp (RF2)

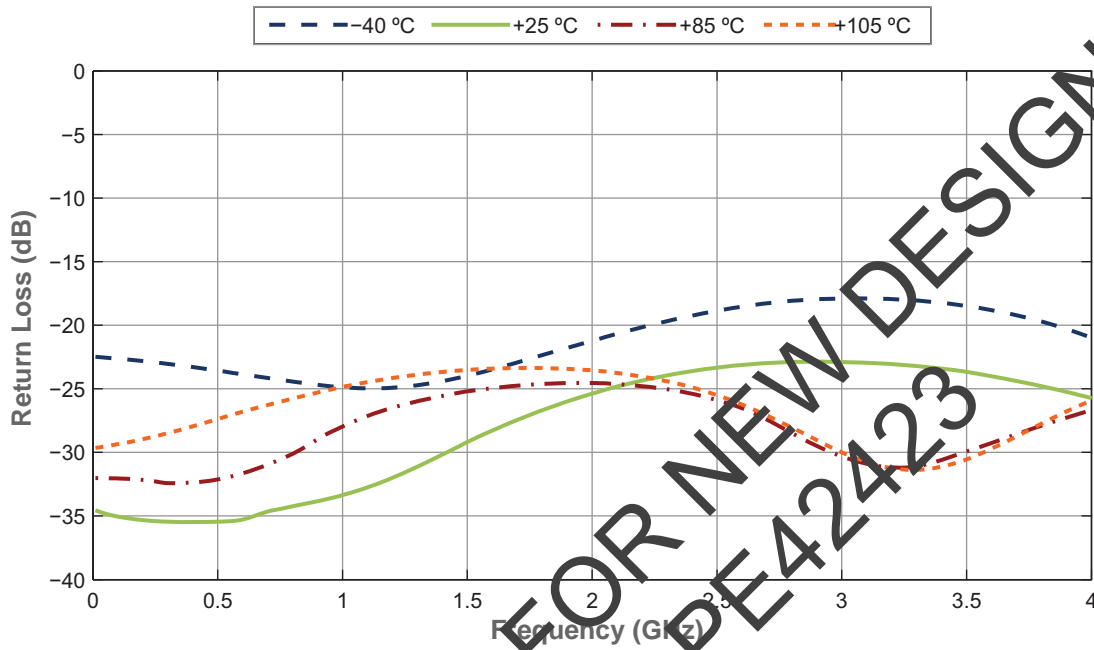
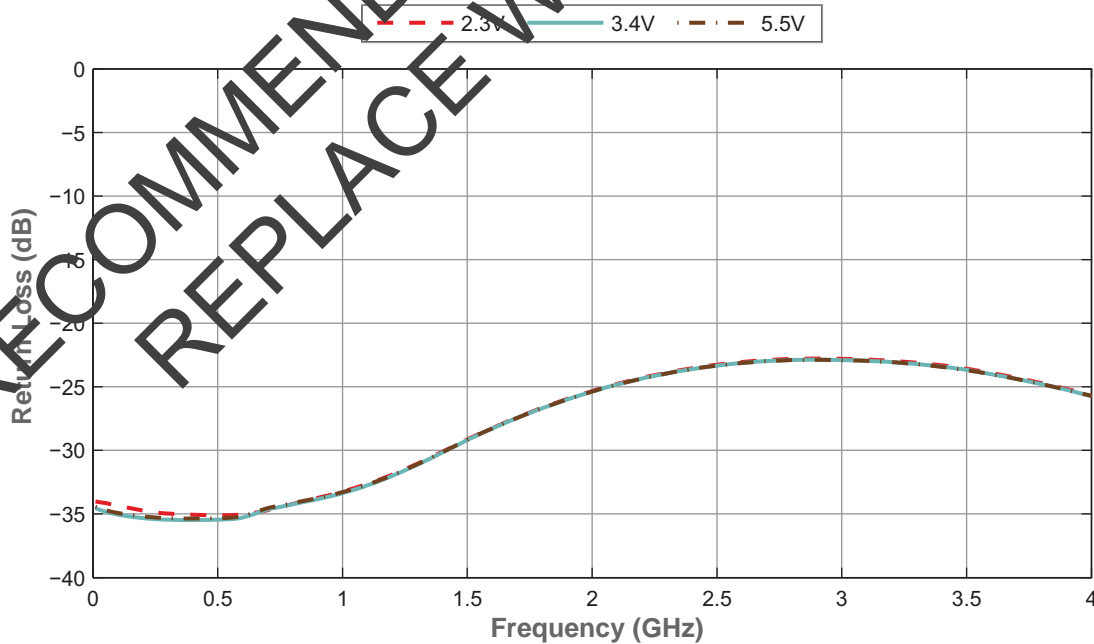

Figure 17 • Terminated Port Return Loss vs V_{DD} (RF2)



NOT RECOMMENDED FOR NEW DESIGNS
REPLACE WITH PE42423

Figure 18 • Isolation vs Temp (RF1–RF2, RF1 Active)

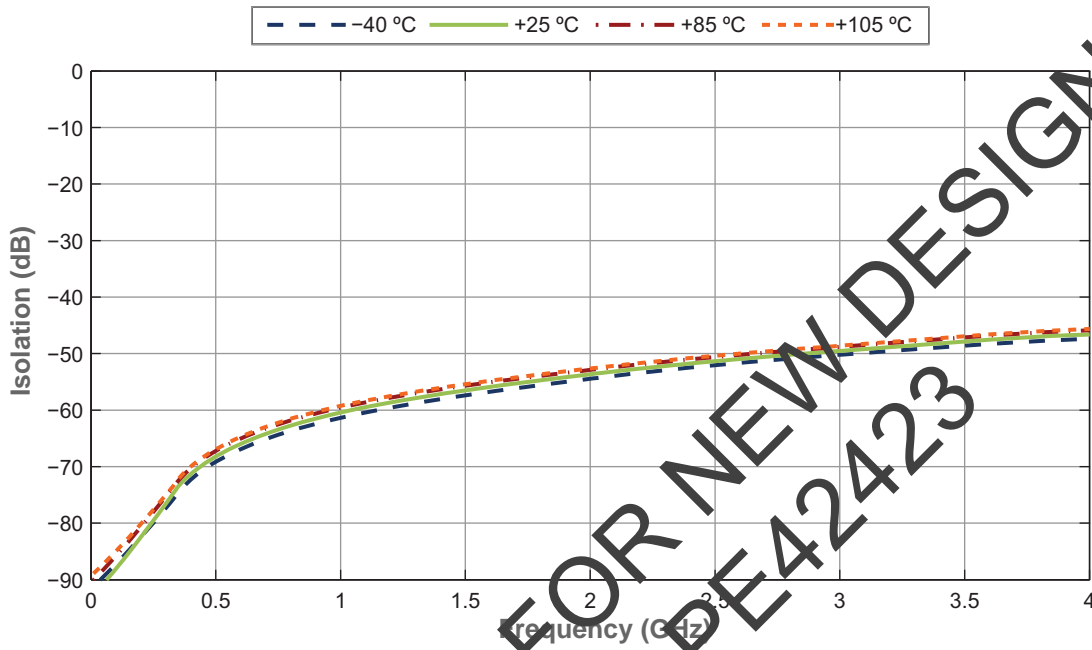
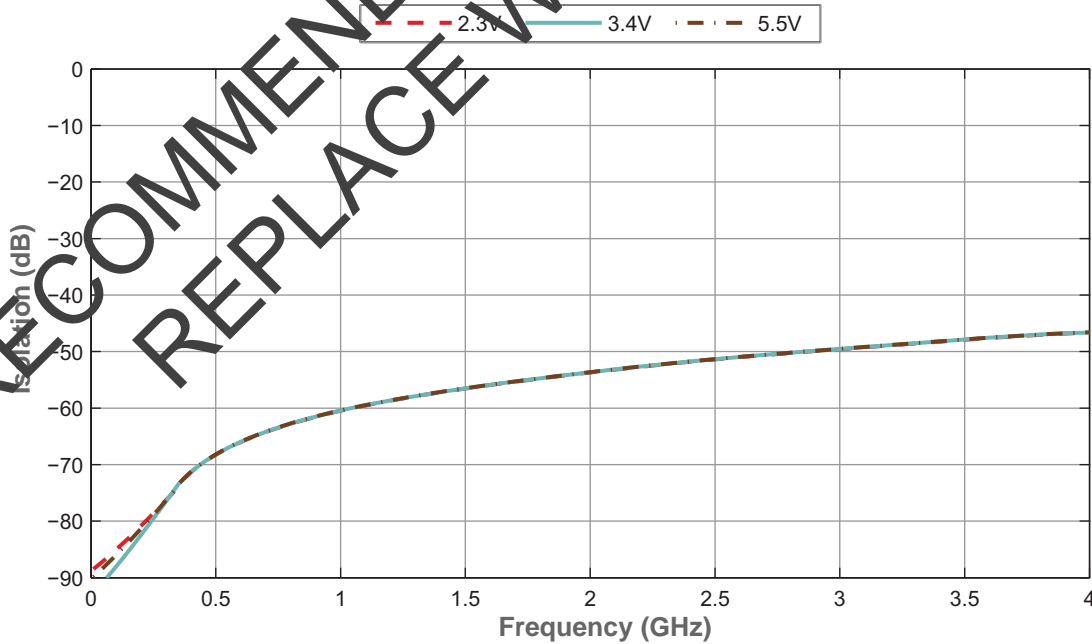

Figure 19 • Isolation vs V_{DD} (RF1–RF2, RF1 Active)



NOT RECOMMENDED FOR NEW DESIGNS
REPLACE WITH PE42423

Figure 20 • Isolation vs Temp (RF2–RF1, RF2 Active)

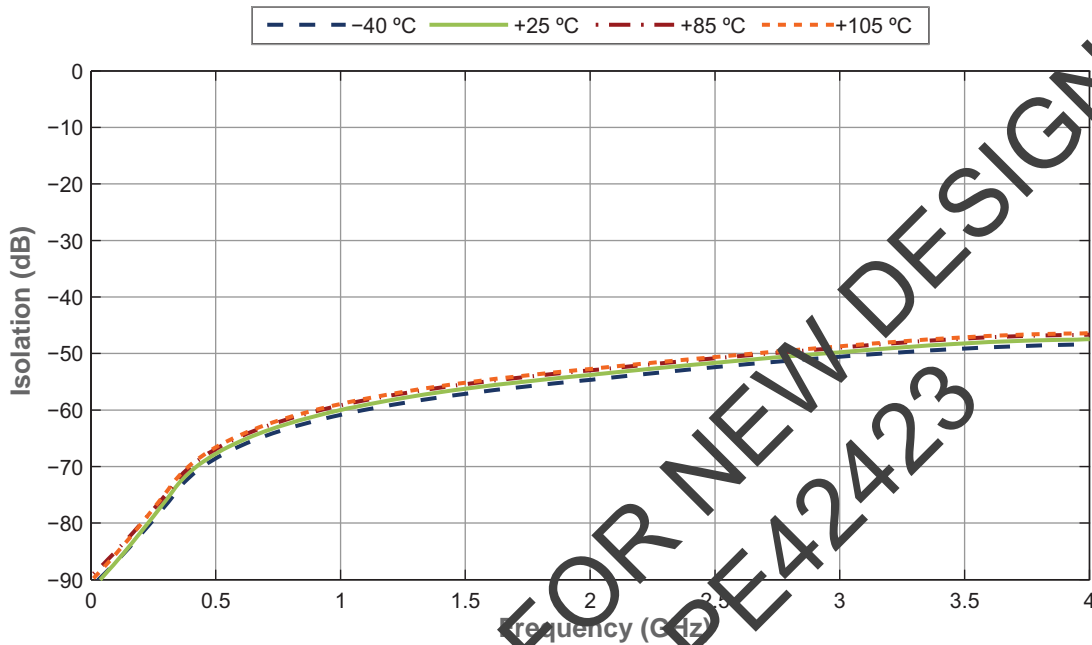
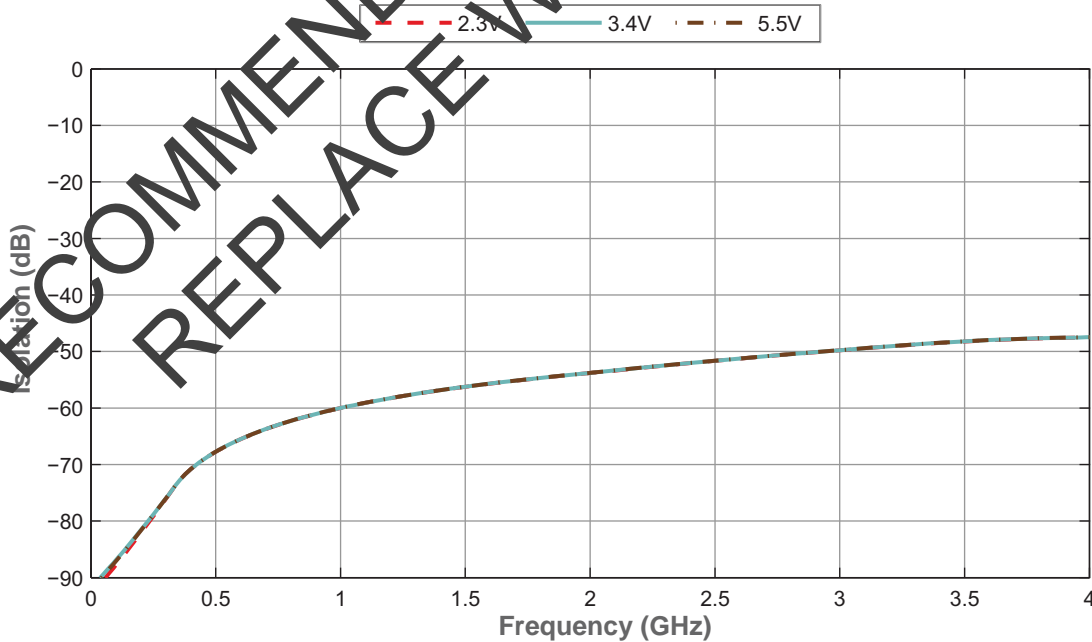

Figure 21 • Isolation vs V_{DD} (RF2–RF1, RF2 Active)



NOT RECOMMENDED FOR NEW DESIGNS
REPLACE WITH PE42423

Figure 22 • Isolation vs Temp (RFC–RF1, RF2 Active)

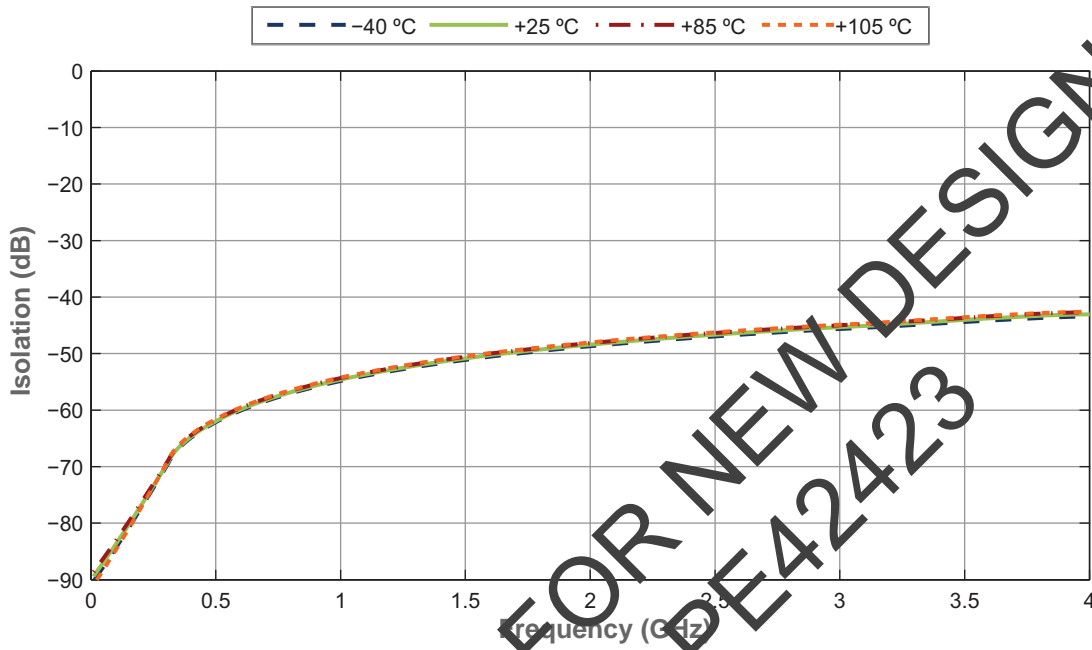

Figure 23 • Isolation vs V_{DD} (RFC–RF1, RF2 Active)

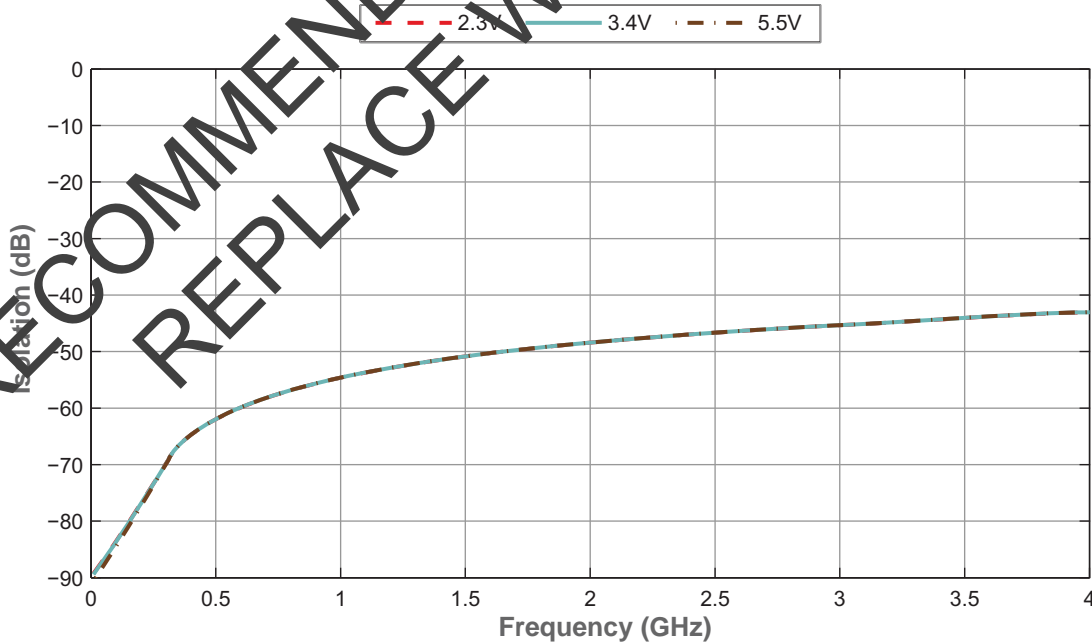

Figure 24 • Isolation vs Temp (RFC–RF2, RF1 Active)

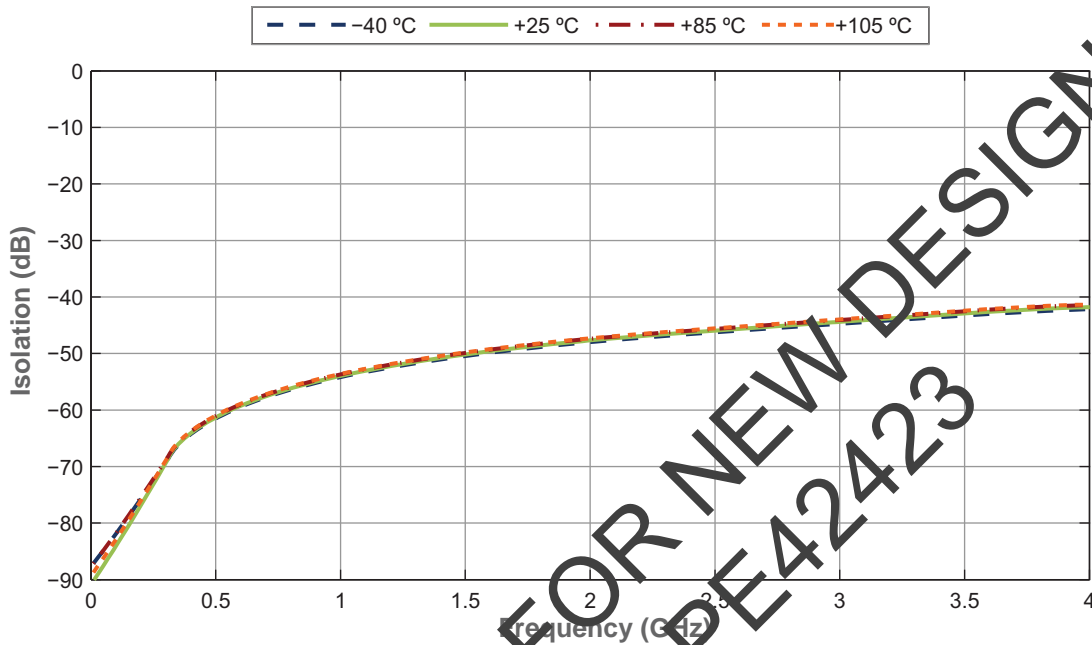
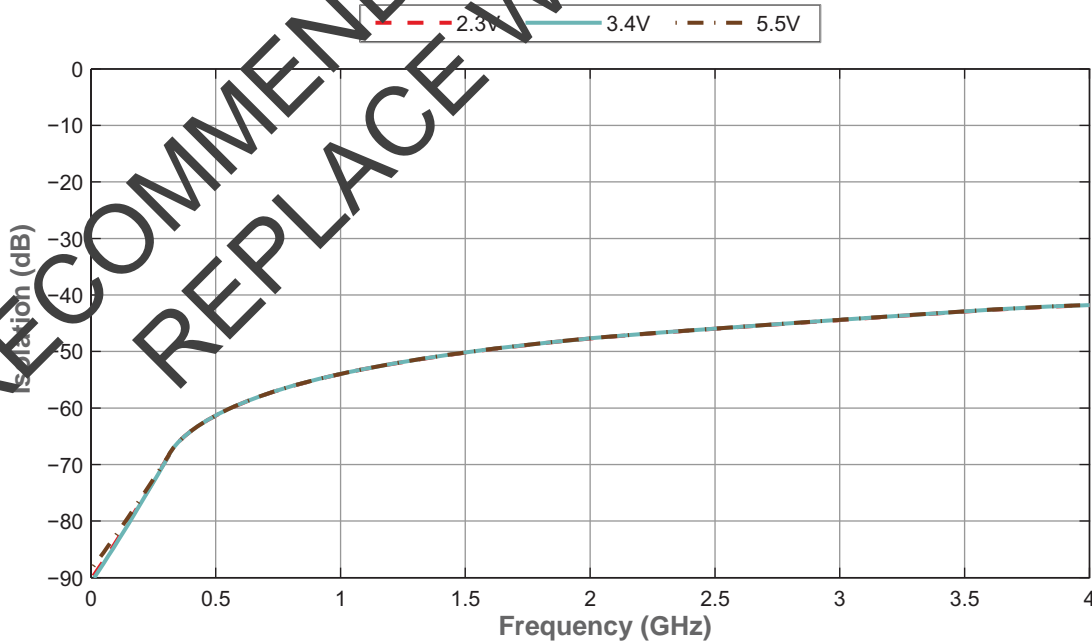

Figure 25 • Isolation vs V_{DD} (RFC–RF2, RF1 Active)



NOT RECOMMENDED FOR NEW DESIGNS
REPLACE WITH PE42423

Evaluation Kit

The SPDT switch evaluation board was designed to ease customer evaluation of Peregrine's PE42822. The RF common port is connected through a 50Ω transmission line via the SMA connector, J1. RF1 and RF2 ports are connected through 50Ω transmission lines via SMA connectors J2 and J3, respectively. A 50Ω through transmission line is available via SMA connectors J5 and J6, which can be used to de-embed the loss of the PCB. J4 provides DC and digital inputs to the device.

For the true performance of the PE42822 to be realized, the PCB should be designed in such a way that RF transmission lines and sensitive DC I/O traces are heavily isolated from one another.

Figure 26 • Evaluation Kit Layout for PE42822

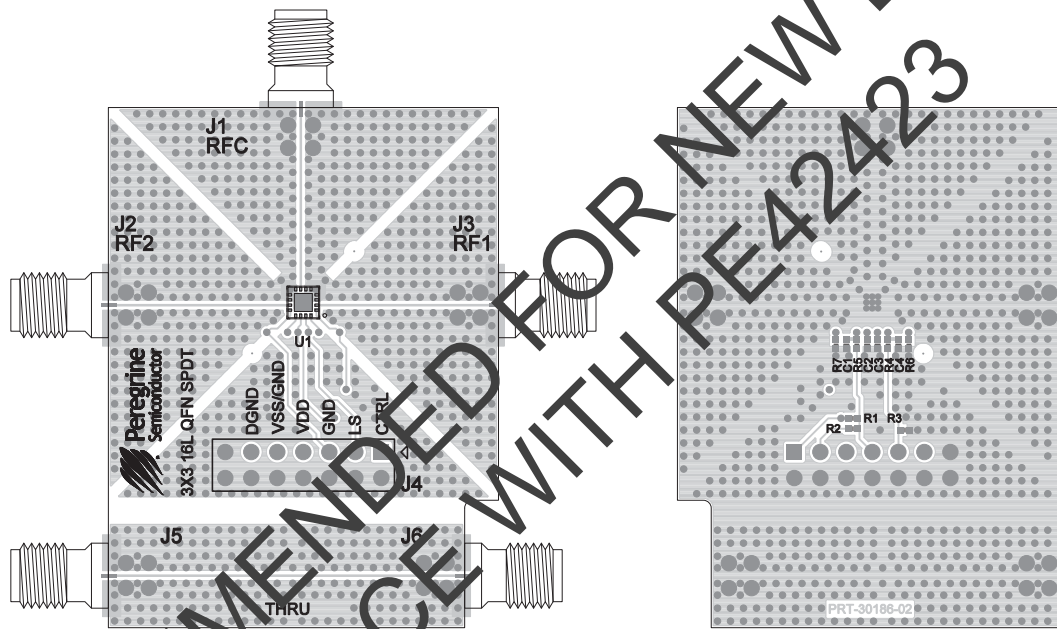

Pin Information

This section provides pinout information for the PE42822. **Figure 27** shows the pin map of this device for the available package. **Table 6** provides a description for each pin.

Figure 27 • Pin Configuration (Top View)

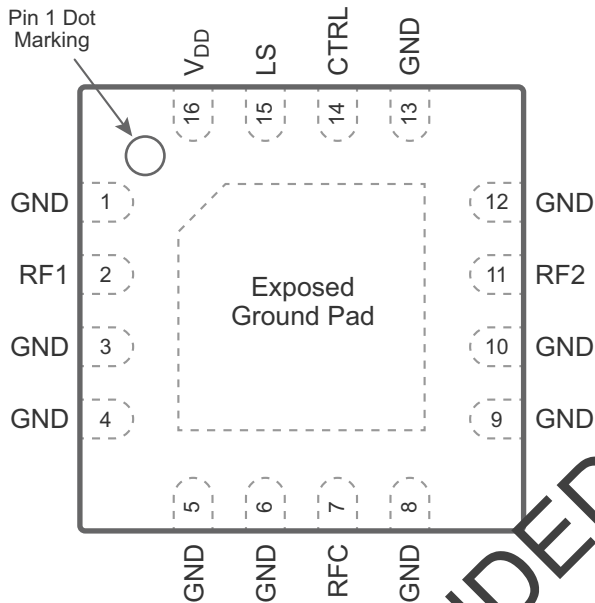

Table 6 • Pin Descriptions for PE42822

| Pin No. | Pin Name | Description |
|---------------------|--------------------|--|
| 1, 3–6, 8–10, 12 13 | GND | Ground |
| 2 | RF1 ^(*) | RF port 1 |
| 7 | RFC ^(*) | RF common port |
| 11 | RF2 ^(*) | RF port 2 |
| 14 | CTRL | Digital control logic input |
| 15 | LS | Logic select—used to determine the definition for the CTRL pin (see Table 6) |
| 16 | V _{DD} | Supply voltage (nominal 3.3V) |
| Exposed Pad | GND | Exposed pad: ground for proper operation |

Note: * RF pins 2, 7 and 11 must be 0 VDC. The RF pins do not require DC blocking capacitors for proper operation if the 0 VDC requirement is met.

NOT RECOMMENDED FOR NEW DESIGNS
REPLACE WITH PE42423

Packaging Information

This section provides packaging data including the moisture sensitivity level, package drawing, package marking and tape and reel information.

Moisture Sensitivity Level

The moisture sensitivity level rating for the PE42822 in the 16-lead 3 × 3 × 0.85 mm QFN package is MSL3.

Package Drawing

Figure 28 • Package Mechanical Drawing for 16-lead 3 × 3 × 0.85 mm QFN

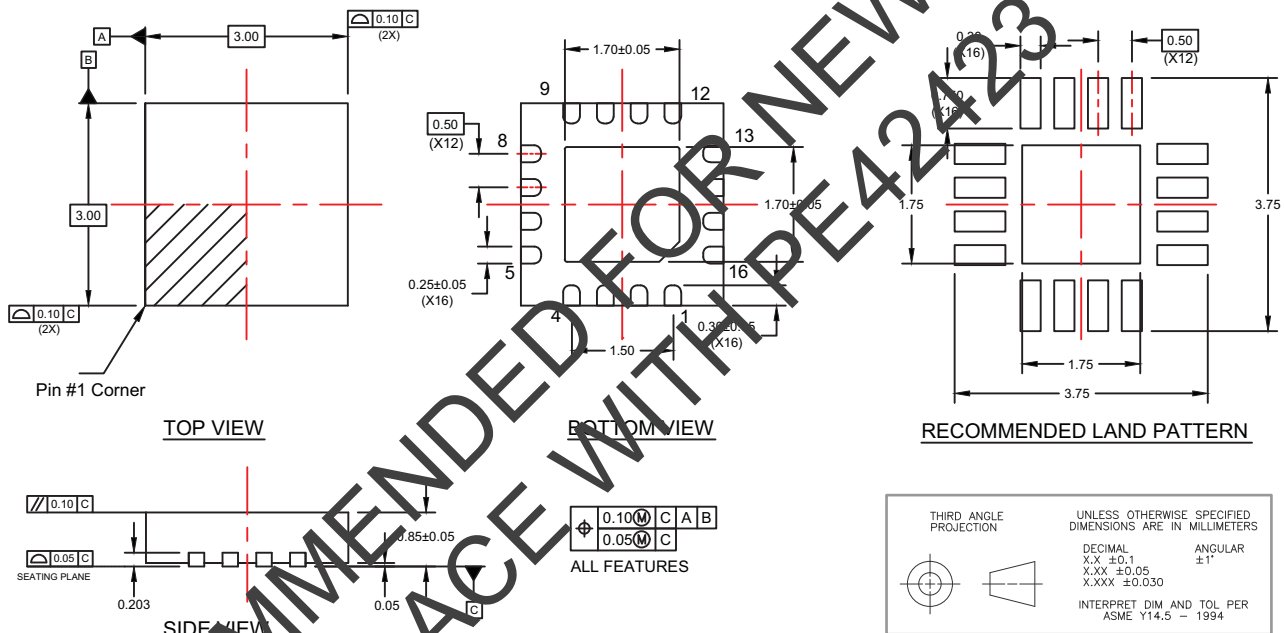

Top-Marking Specification

Figure 29 • Package Marking Specifications for PE42822



- = Pin 1 indicator
- YY = Last two digits of assembly year
- WW = Assembly work week
- ZZZZZZ = Assembly lot code (maximum six characters)

Tape and Reel Specification

Figure 30 • Tape and Reel Specifications for 16-lead 3 × 3 × 0.85 mm QFN

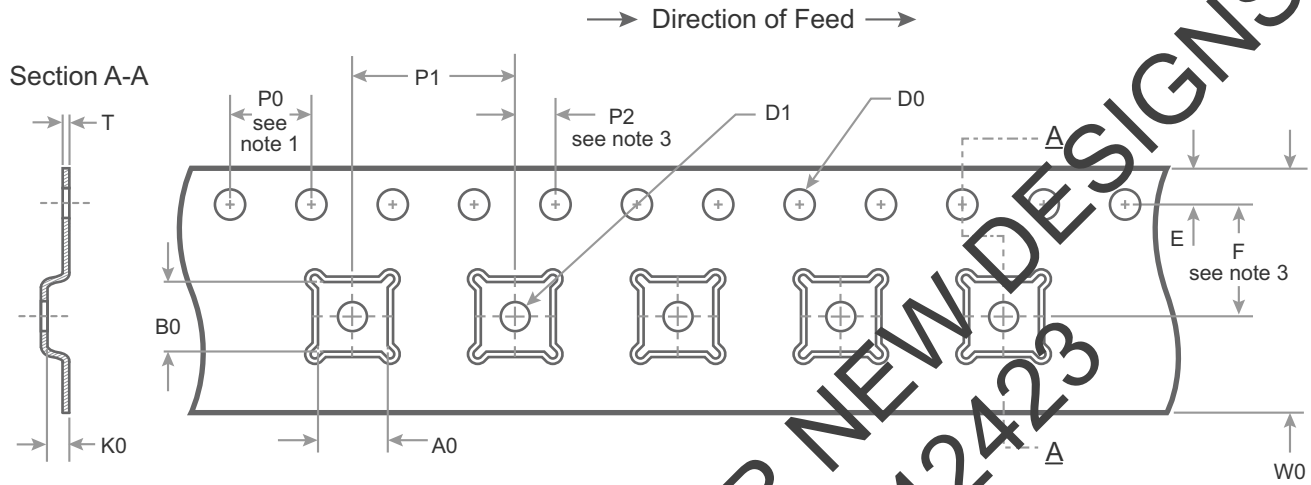

| | |
|----|--------------------|
| A0 | 3.3 |
| B0 | 3.3 |
| K0 | 1.10 |
| D0 | 1.50 + 0.10/ -0.00 |
| D1 | 1.50 min |
| E | 1.75 ± 0.10 |
| F | 5.50 ± 0.05 |
| P0 | 4.00 |
| P1 | 8.00 |
| P2 | 2.00 ± 0.05 |
| T | 0.30 ± 0.05 |
| W0 | 12.00 ± 0.30 |

Notes:

1. 10 Sprocket hole pitch cumulative tolerance ±0.2
2. Camber in compliance with EIA 4-1
3. Pocket position relative to sprocket hole measured as true position of pocket, not pocket hole

Dimensions are in millimeters unless otherwise specified

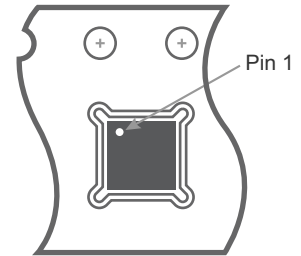

Device Orientation in Tape

Ordering Information

Table 7 lists the available ordering codes for the PE42822 as well as available shipping methods.

Table 7 • Ordering Codes for PE42822

| Ordering Codes | Description | Packaging | Shipping Method |
|----------------|------------------------|----------------------------|-----------------|
| PE42822A-Z | PE42822 SPDT RF switch | Green 16-lead 3 × 3 mm QFN | 3000 units/T&R |
| EK42822-01 | PE42822 Evaluation kit | Evaluation kit | 1/Box |

Document Categories

Advance Information

The product is in a formative or design stage. The datasheet contains design target specifications for product development. Specifications and features may change in any manner without notice.

Preliminary Specification

The datasheet contains preliminary data. Additional data may be added at a later date. Peregrine reserves the right to change specifications at any time without notice in order to supply the best possible product.

Product Specification

The datasheet contains final data. In the event Peregrine decides to change the specifications, Peregrine will notify customers of the intended changes by issuing a CNF (Customer Notification Form).

Sales Contact

For additional information, contact Sales at sales@psemi.com.

Disclaimers

The information in this document is believed to be reliable. However, Peregrine assumes no liability for the use of this information. Use shall be entirely at the user's own risk. No patent rights or licenses to any circuits described in this document are implied or granted to any third party. Peregrine's products are not designed or intended for use in devices or systems intended for surgical implant, or in other applications intended to support or sustain life, or in any application in which the failure of the Peregrine product could create a situation in which personal injury or death might occur. Peregrine assumes no liability for damages, including consequential or incidental damages, arising out of the use of its products in such applications.

Patent Statement

Peregrine products are protected under one or more of the following U.S. patents: patents.psemi.com

Copyright and Trademark

©2015–2016, Peregrine Semiconductor Corporation. All rights reserved. The Peregrine name, logo, UTSi and UltraCMOS are registered trademarks and HaRP, MultiSwitch and DuNE are trademarks of Peregrine Semiconductor Corp.