

Product Description

The PE42543 is a HaRP™ technology-enhanced absorptive SP4T RF switch designed for use in test/ATE, microwave and other wireless applications. This broadband general purpose switch is a pin-compatible version of the PE42542 with faster switching time and settling time. It exhibits low insertion loss, high isolation and linearity performance from 9 kHz through 18 GHz. No blocking capacitors are required if DC voltage is not present on the RF ports.

The PE42543 is manufactured on pSemi's UltraCMOS[®] process, a patented variation of silicon-on-insulator (SOI) technology on a sapphire substrate.

pSemi's HaRP technology enhancements deliver high linearity and excellent harmonics performance. It is an innovative feature of the UltraCMOS process, offering the performance of GaAs with the economy and integration

Features

- HaRP technology-enhanced
 - Fast settling time
 - No gate and phase lag
 - No drift in insertion loss and phase
- Fast switching time of 500 ns
- Low insertion loss
 - 1.20 dB @ 3 GHz
 - 2.30 dB @ 13.5 GHz
 - 3.10 dB @ 16 GHz
 - 4.10 dB @ 18 GHz
- High isolation
 - 55 dB @ 3 GHz
 - 32 dB @ 13.5 GHz
 - 28 dB @ 16 GHz
 - 25 dB @ 18 GHz
- ESD performance
 - 2000V HBM on all pins
 - 150V MM on all pins
 - 250V CDM on all pins

Figure 1. Functional Diagram

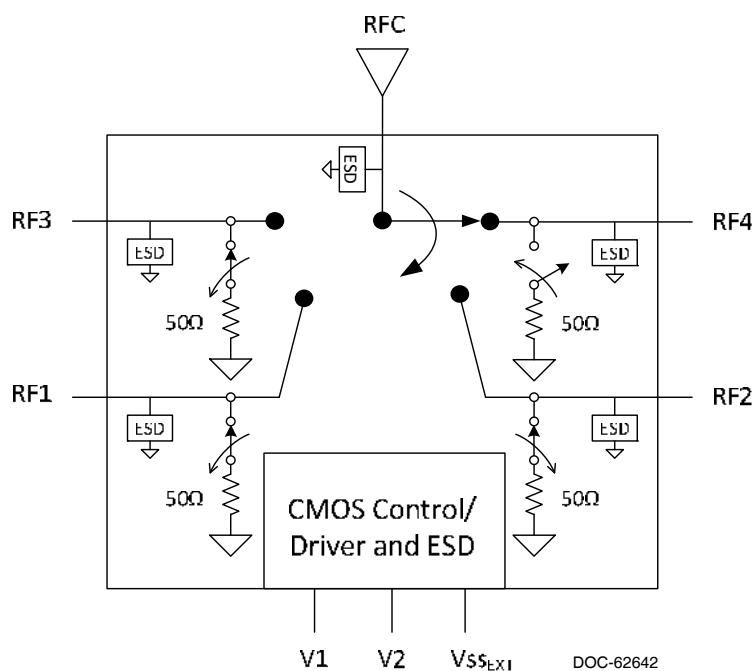

Figure 2. Package Type
29-lead 4 × 4 mm LGA

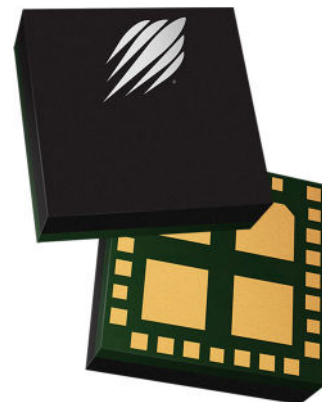

Table 1. Electrical Specifications @ 25°C ($Z_S = Z_L = 50\Omega$), unless otherwise noted
Normal Mode¹: $V_{DD} = 3.3V$, $V_{SS_EXT} = 0V$ or Bypass Mode²: $V_{DD} = 3.4V$, $V_{SS_EXT} = -3.4V$

Parameter	Path	Condition	Min	Typ	Max	Unit
Operating frequency			9 k		18 G	Hz
Insertion loss	RFC–RFX	9 kHz–10 MHz		0.70	0.85	dB
		10–3000 MHz		1.20	1.50	dB
		3000–7500 MHz		1.65	2.05	dB
		7500–10000 MHz		2.10	2.55	dB
		10000–13500 MHz		2.30	2.80	dB
		13500–16000 MHz		3.10	3.60	dB
		16000–18000 MHz		4.10	4.70	dB
Isolation	RFX–RFX	9 kHz–10 MHz	80	90		dB
		10–3000 MHz	53	55		dB
		3000–7500 MHz	46	48		dB
		7500–10000 MHz	41	43		dB
		10000–13500 MHz	36	38		dB
		13500–16000 MHz	31	33		dB
		16000–18000 MHz	27	29		dB
Isolation	RFC–RFX	9 kHz–10 MHz	78	90		dB
		10–3000 MHz	54	55		dB
		3000–7500 MHz	41	42		dB
		7500–10000 MHz	36	38		dB
		10000–13500 MHz	31	32		dB
		13500–16000 MHz	27	28		dB
		16000–18000 MHz	24	25		dB
Return loss (active and common port)	RFC–RFX	9 kHz–10 MHz		22		dB
		10–3000 MHz		15		dB
		3000–18000 MHz		14		dB
Return loss (terminated port)	RFX	9 kHz–18000 MHz		14		dB
Input 0.1dB compression point ³	RFC–RFX			Fig. 4		dBm
Input IP2	RFC–RFX	30–18000 MHz		113		dBm
Input IP3	RFC–RFX	30–18000 MHz		59		dBm
Settling time		50% CTRL to 0.05 dB final value		2	3	μ s
Switching time		50% CTRL to 90% or 10% of final value		500	800	ns

Note: 1. Normal mode: connect V_{SS_EXT} (pin 29) to GND ($V_{SS_EXT} = 0V$) to enable internal negative voltage generator.

2. Bypass mode: use V_{SS_EXT} (pin 29) to bypass and disable internal negative voltage generator.

3. The input 0.1dB compression point is a linearity figure of merit. Refer to Table 3 for the RF input power P_{MAX} (50 Ω).

Figure 3. Pin Configuration (Top View)

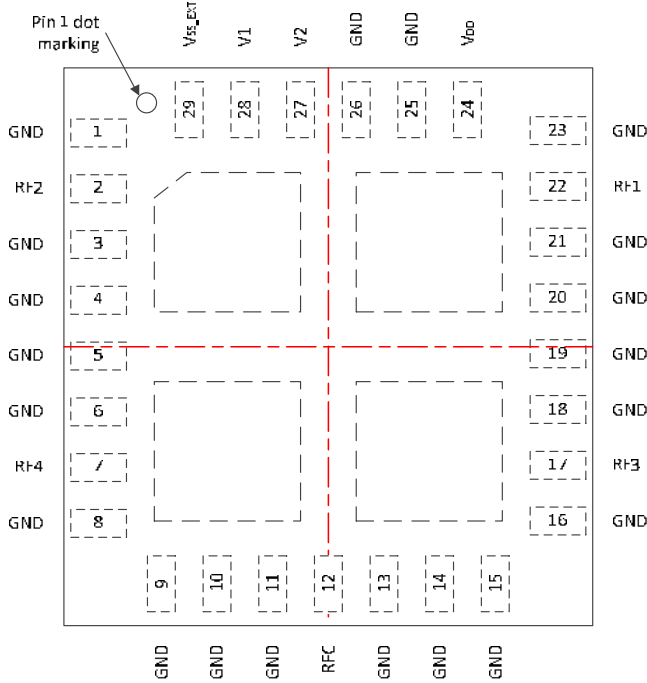

Table 2. Pin Descriptions

Pin #	Pin Name	Description
1, 3–6, 8–11, 13–16, 18–21, 23,	GND	Ground
2	RF2 ¹	RF port 2
7	RF4 ¹	RF port 4
12	RFC ¹	RF common
17	RF3 ¹	RF port 3
22	RF1 ¹	RF port 1
24	V _{DD}	Supply voltage (nominal 3.3V)
27	V2	Digital control logic input 2
28	V1	Digital control logic input 1
29	V _{SS_EXT} ²	External V _{SS} negative voltage control
Pad	GND	Exposed pad: Ground for proper operation

Notes: 1. RF pins 2, 7, 12, 17, and 22 must be at 0 VDC. The RF pins do not require DC blocking capacitors for proper operation if the 0 VDC requirement is met.
 2. Use V_{SS_EXT} (pin 29) to bypass and disable internal negative voltage generator. Connect V_{SS_EXT} (pin 29) to GND (V_{SS_EXT} = 0V) to enable internal negative voltage generator.

Table 3. Operating Ranges

Parameter	Symbol	Min	Typ	Max	Unit
Normal mode ¹ (V _{SS_EXT} = 0V)					
Supply voltage	V _{DD}	2.3		5.5	V
Supply current	I _{DD}		120	200	µA
Bypass mode ² (V _{SS_EXT} = -3.4V)					
Supply voltage (V _{DD} ≥ 3.4V for Table 1)	V _{DD}	2.7	3.4	5.5	V
Supply current	I _{DD}		50	80	µa
Negative supply voltage	V _{SS_EXT}	-3.6		-3.2	V
Negative supply current	I _{SS}	-40	-16		µa
Normal or Bypass mode					
Digital input high	V _{IH}	1.17		3.6	V
Digital input low	V _{IL}	-0.3		0.6	V
RF input power, CW (RFC–RFX) ³ 9 kHz–27.5 MHz ≥ 27.5 MHz–18 GHz	P _{MAX,CW}				Fig. 4 30 dBm
RF input power, pulsed (RFC–RFX) ⁴ 9 kHz–27.5 MHz ≥ 27.5 MHz–18 GHz	P _{MAX,PULSED}				Fig. 4 32 dBm
RF input power into terminated ports, CW (RFX) ³ 9 kHz–18.8 MHz ≥ 18.8 MHz–18 GHz	P _{MAX,TERM}				Fig. 4 20 dBm
Operating temperature	T _{OP}	-40	+25	+85	°C

Notes: 1. Normal mode: connect V_{SS_EXT} (pin 29) to GND (V_{SS_EXT} = 0V) to enable internal negative voltage generator
 2. Bypass mode: use V_{SS_EXT} (pin 29) to bypass and disable internal negative voltage generator
 3. 100% duty cycle, all bands, 50Ω
 4. Pulsed, 5% duty cycle of 4620 µs period, 50Ω

Table 4. Absolute Maximum Ratings

Parameter/Condition	Symbol	Min	Max	Unit
Maximum junction tempera-			+150	°C
Storage temperature range	T _{ST}	-60	+150	°C
Supply voltage	V _{DD}	-0.3	5.5	V
Digital input voltage (V1, V2)	V _{CTRL}	-0.3	3.6	V
RF input power, CW (RFC–RFX) ¹ 9 kHz–27.5 MHz ≥ 27.5 MHz–18 GHz	P _{MAX,ABS}		Fig. 4 33	dBm dBm
RF input power, pulsed (RFC–RFX) ² 9 kHz–27.5 MHz ≥ 27.5 MHz–18 GHz	P _{MAX,PULSED}		Fig. 4 34	dBm dBm
RF input power into terminated ports, CW (RFX) ¹ 9 kHz–18.8 MHz ≥ 18.8 MHz–18 GHz	P _{MAX,TERM}		Fig. 4 22	dBm dBm
Storage temperature range	T _{ST}	-65	+150	°C
ESD voltage HBM ³ , all pins	V _{ESD,HBM}		2000	V
ESD voltage MM ⁴ , all pins	V _{ESD,MM}		150	V
ESD voltage CDM ⁵ , all pins	V _{ESD,CDM}		250	V

- Notes: 1. 100% duty cycle, all bands, 50Ω
2. Pulsed, 5% duty cycle of 4620 μs period, 50Ω
3. Human Body Model (MIL-STD 883 Method 3015)
4. Machine Model (JEDEC JESD22-A115)
5. Charged Device Model (JEDEC JESD22-C101)

Exceeding absolute maximum ratings may cause permanent damage. Operation should be restricted to the limits in the Operating Ranges table. Operation between operating range maximum and absolute maximum for extended

Electrostatic Discharge (ESD) Precautions

When handling this UltraCMOS device, observe the same precautions that you would use with other ESD-sensitive devices. Although this device contains circuitry to protect it from damage due to ESD, precautions should be taken to avoid

Latch-Up Avoidance

Unlike conventional CMOS devices, UltraCMOS devices are immune to latch-up.

Switching Frequency

The PE42543 has a maximum 25 kHz switching rate when the internal negative voltage generator is used (pin 29 = GND). Switching frequency describes the time duration between switching events. Switching time is the duration between the point the control signal reaches 50% of the final value and the point the output signal reaches

Optional External V_{SS} Control (V_{SS_EXT})

For proper operation, the V_{SS_EXT} control pin must be grounded or tied to the V_{SS} voltage specified in Table 3. When the V_{SS_EXT} control pin is grounded, FETs in the switch are biased with an internal negative voltage generator. For applications that require the lowest possible spur performance, V_{SS_EXT} can be applied externally to bypass the

Spurious Performance

The typical spurious performance of the PE42543 is -150 dBm when V_{SS_EXT} = 0V (pin 29 = GND). If further improvement is desired, the internal negative voltage generator can be disabled by setting V_{SS_EXT} = -3.4V.

Table 5. Truth Table

State	V1	V2
RF1 on	0	0
RF2 on	1	0
RF3 on	0	1
RF4 on	1	1

Moisture Sensitivity Level

The Moisture Sensitivity Level rating for the PE42543 in the 29-lead 4 × 4 mm LGA package is MSL3.

Hot-Switching Capability

The maximum hot switching capability of the PE42543 is 20 dBm from 18.8 MHz to 18 GHz. The maximum hot switching capability below 18.8 MHz does not exceed the maximum RF CW terminated power, see Figure 4. Hot switching occurs when RF power is applied while switching between RF ports.

Figure 4a. Power De-rating Curve for 9 kHz–18 GHz @ 25°C Ambient (50Ω)

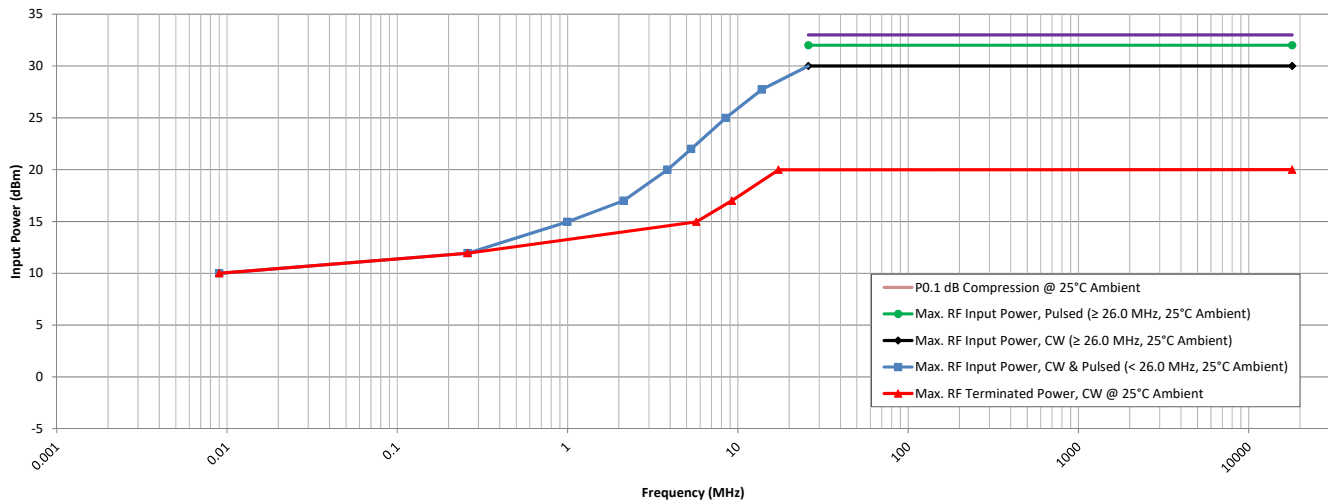
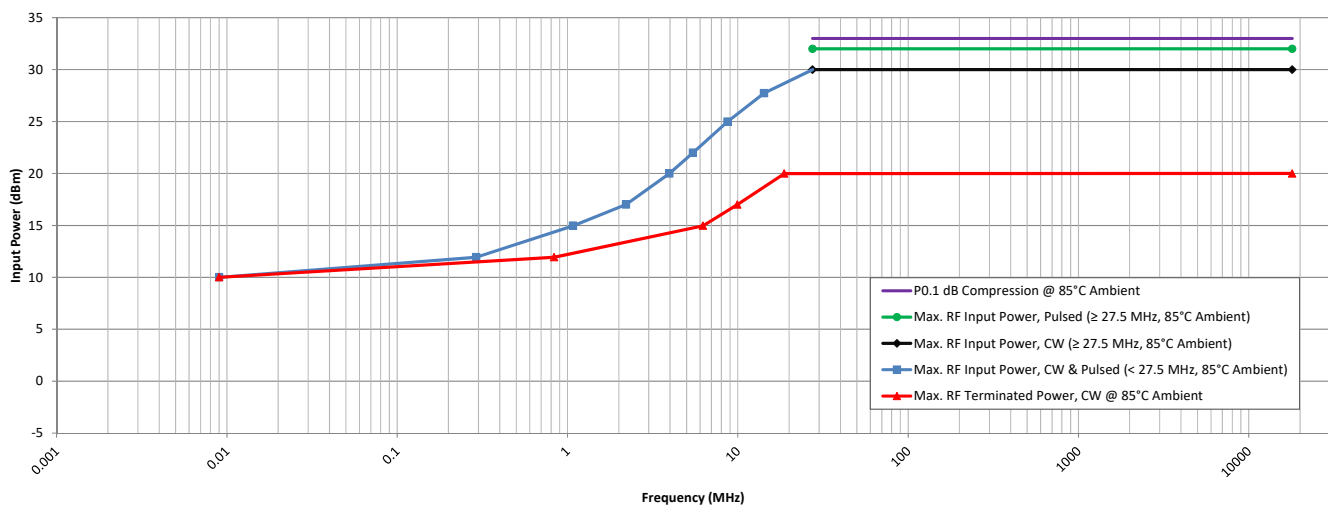

Figure 4b. Power De-rating Curve for 9 kHz–18 GHz @ 85°C Ambient (50Ω)



Typical Performance Data @ 25°C and $V_{DD} = 3.3V$ ($Z_S = Z_L = 50\Omega$), unless otherwise noted

Figure 5. Insertion Loss (RFC–RFX)

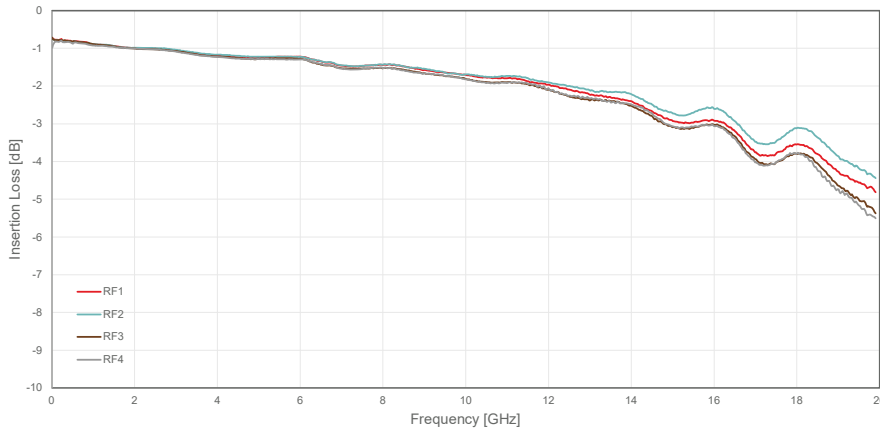

Figure 6. Insertion Loss vs. Temp (RFC–RFX)

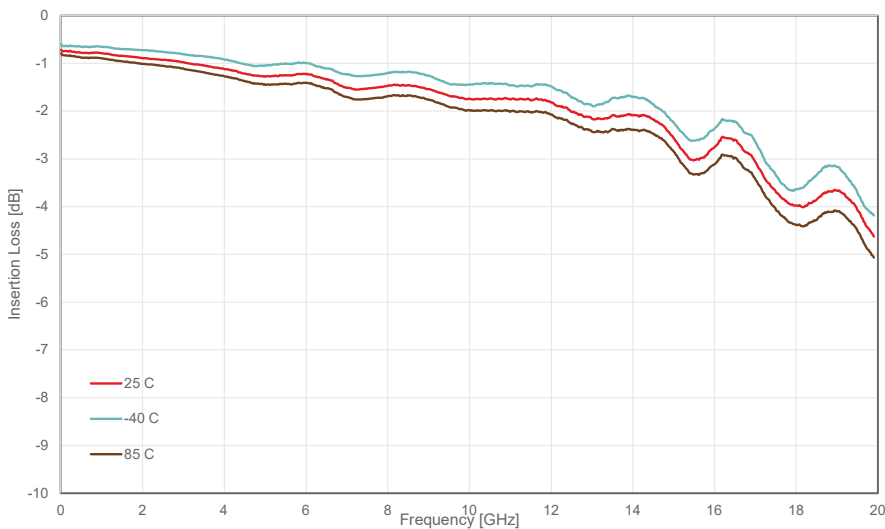
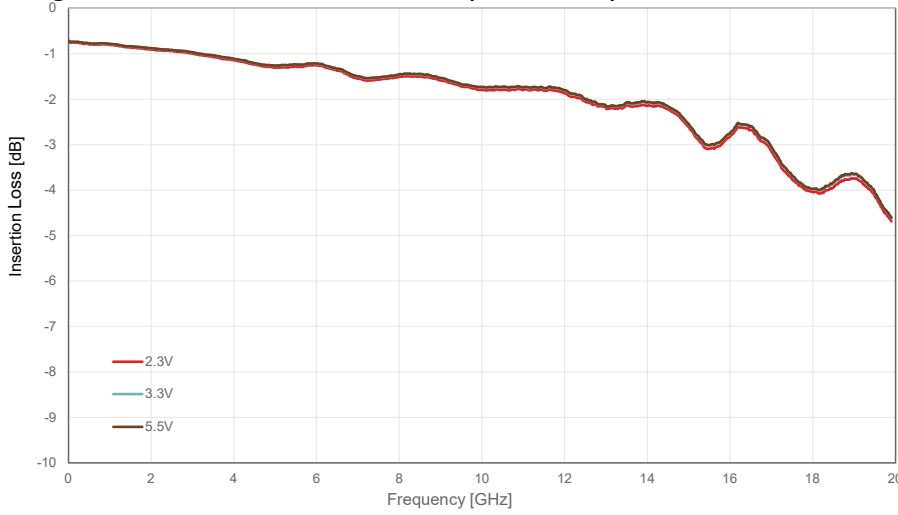

Figure 7. Insertion Loss vs. V_{DD} (RFC–RFX)



Typical Performance Data @ 25°C and $V_{DD} = 3.3V$ ($Z_S = Z_L = 50\Omega$), unless otherwise noted

Figure 8. RFC Port Return Loss vs. Temp

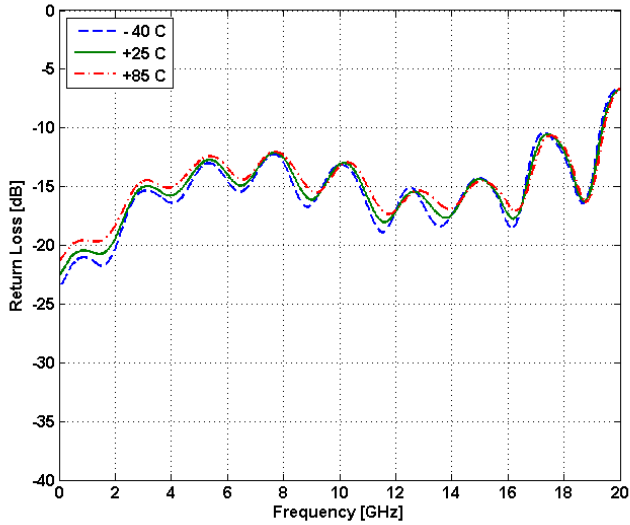

Figure 9. RFC Port Return Loss vs. V_{DD}

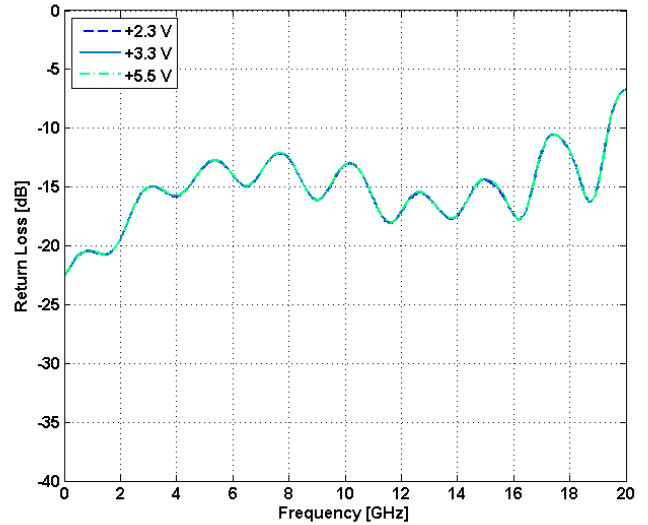

Figure 10. Active Port Return Loss vs. Temp

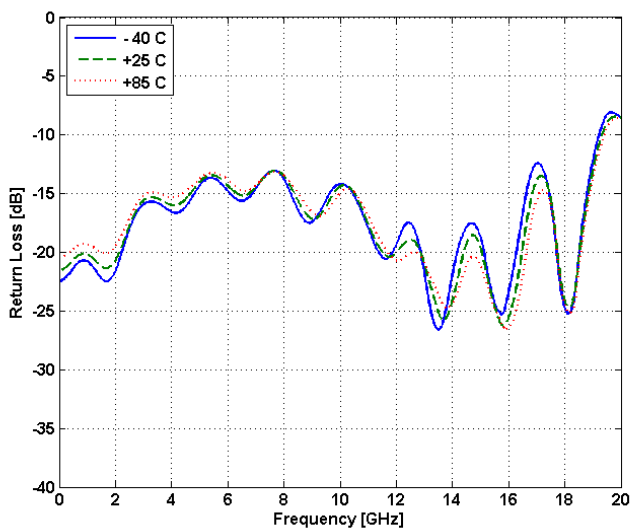
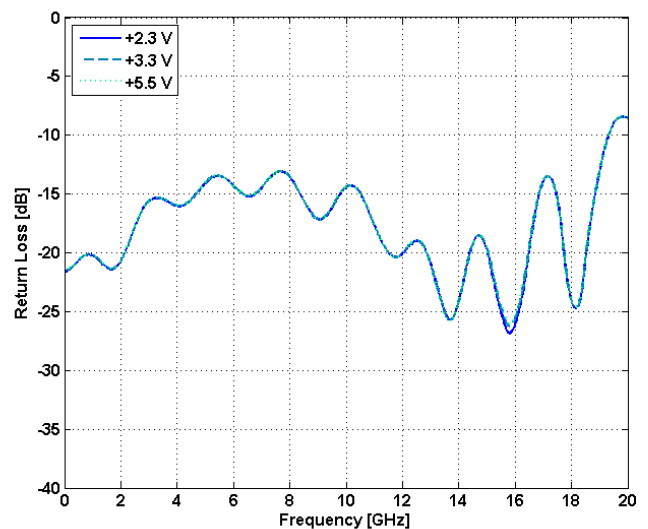

Figure 11. Active Port Return Loss vs. V_{DD}



Typical Performance Data @ 25°C and $V_{DD} = 3.3V$ ($Z_S = Z_L = 50\Omega$), unless otherwise noted

Figure 12. Terminated Port Return Loss vs. Temp

Figure 13. Terminated Port Return Loss vs. V_{DD}

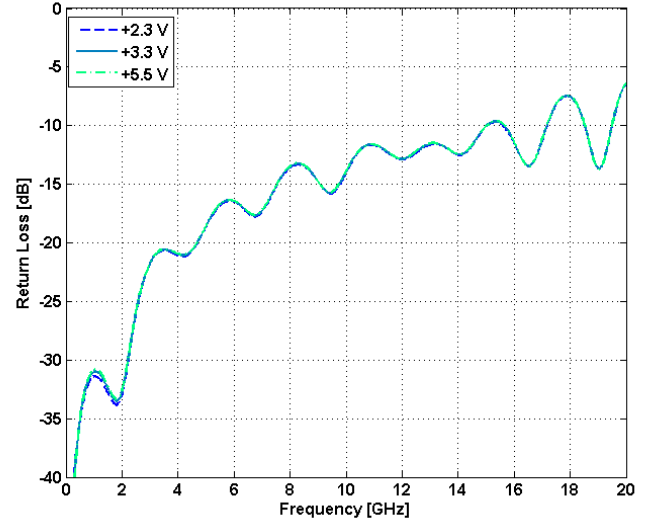
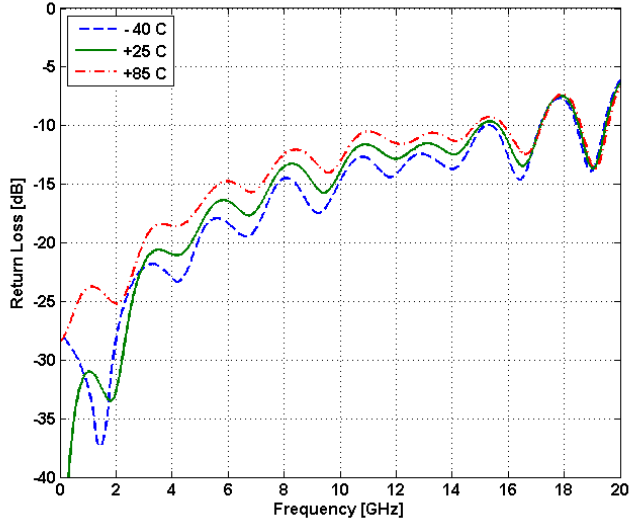

Typical Performance Data @ 25°C and $V_{DD} = 3.3V$ ($Z_S = Z_L = 50\Omega$), unless otherwise noted

Figure 14. Isolation vs. Temp (RFX–RFX)*

Figure 15. Isolation vs. V_{DD} (RFX–RFX)*

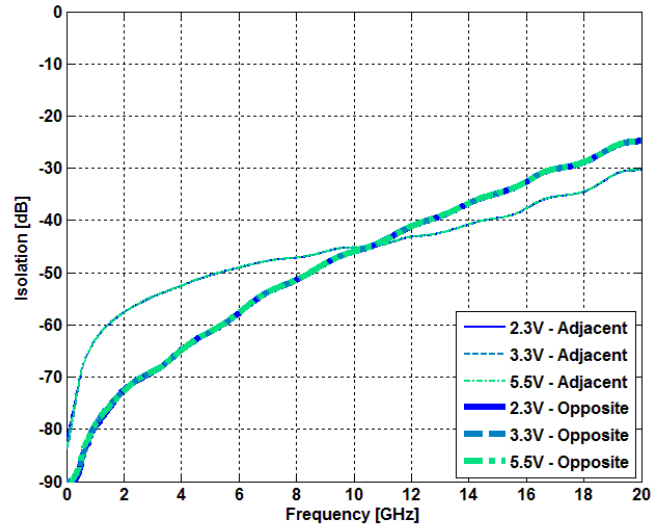
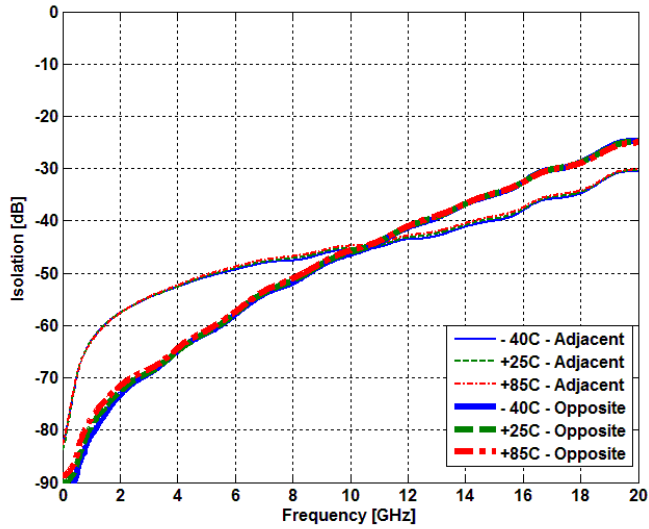

Note: * RF1 adjacent to RF3
RF2 adjacent to RF4
RF1 and RF3 opposite to RF2 and RF4

Typical Performance Data @ 25°C and $V_{DD} = 3.3V$ ($Z_S = Z_L = 50\Omega$), unless otherwise noted

Figure 16. Isolation vs. Temp
(RFC–RFX, RF1 or RF2 Active)*

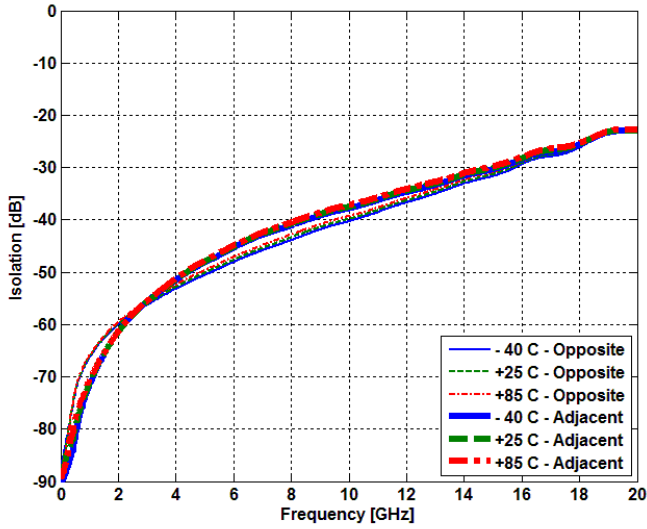

Figure 17. Isolation vs. V_{DD}
(RFC–RFX, RF1 or RF2 Active)*

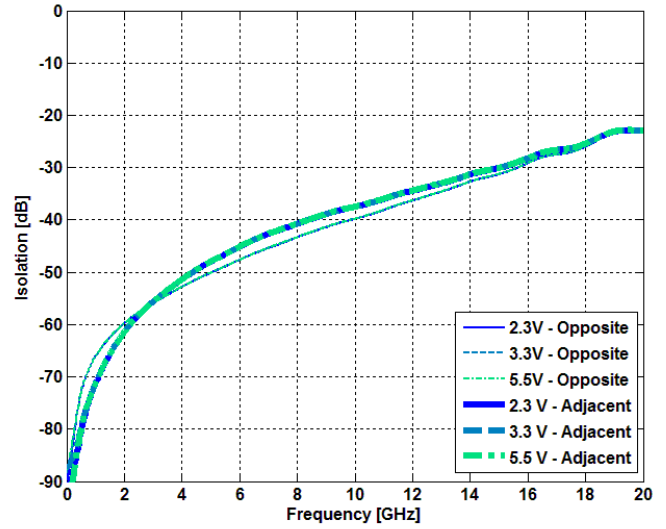

Figure 18. Isolation vs. Temp
(RFC–RFX, RF3 or RF4 Active)*

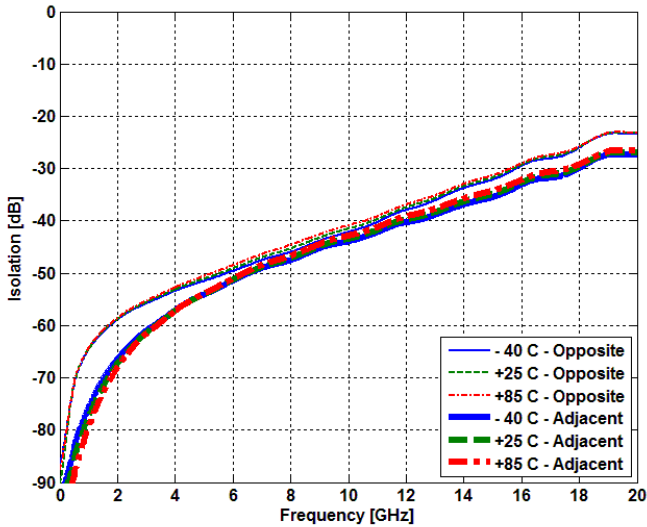
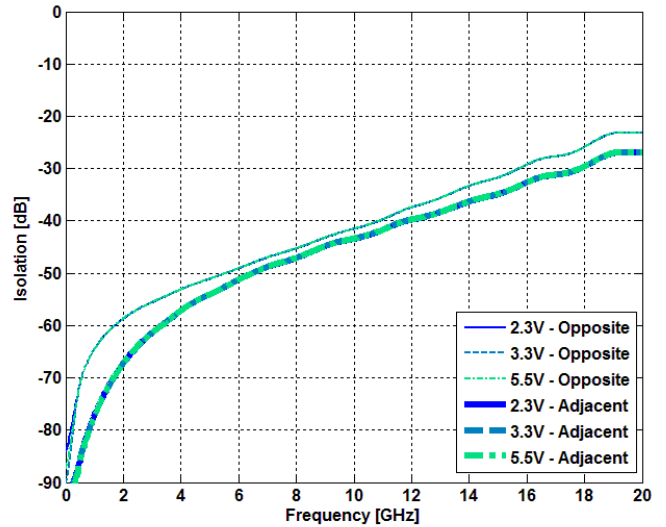

Figure 19. Isolation vs. V_{DD}



Note: * RF1 adjacent to RF3
RF2 adjacent to RF4
RF1 and RF3 opposite to RF2 and RF4

Evaluation Kit

The SP4T switch evaluation board was designed to ease customer evaluation of pSemi's PE42543. The RF common port is connected through a 50Ω transmission line via the SMA connector, J1. RF1, RF2, RF3 and RF4 ports are connected through 50Ω transmission lines via SMA connectors J4, J3, J2 and J5, respectively. A 50Ω through transmission line is available via SMA connectors J6 and J7, which can be used to de-embed the loss of the PCB. J13 provides DC and digital inputs to the device.

The board is constructed of a four metal layer material with a total thickness of 62 mils. The top RF layer is Rogers 4360 material with a thickness of 32 mils and the $\epsilon_r = 6.4$. The middle layers provide ground for the transmission lines. The transmission lines were designed using a coplanar waveguide with ground plane model using a trace width of 18 mils, trace gaps of 7 mils and metal thickness of 2.1 mils.

For the true performance of the PE42543 to be realized, the PCB should be designed in such a way that RF transmission lines and sensitive DC I/O traces are heavily isolated from one another.

High frequency insertion loss and return loss can be further improved by external series inductive tuning traces in the customer application board layout. For example, to improve 12–18 GHz performance, use ~180 pH for RFX ports and ~50 pH for RFC port.

Vector de-embed is recommended to more accurately calculate the performance of the DUT. Refer to Application Note 39 "*Vector De-embedding of the PE42542 and PE42543 SP4T RF Switches*" for additional information. The half thru line data file can be downloaded from pSemi's website to facilitate the vector de-embedding.

Figure 20. Evaluation Board Layout

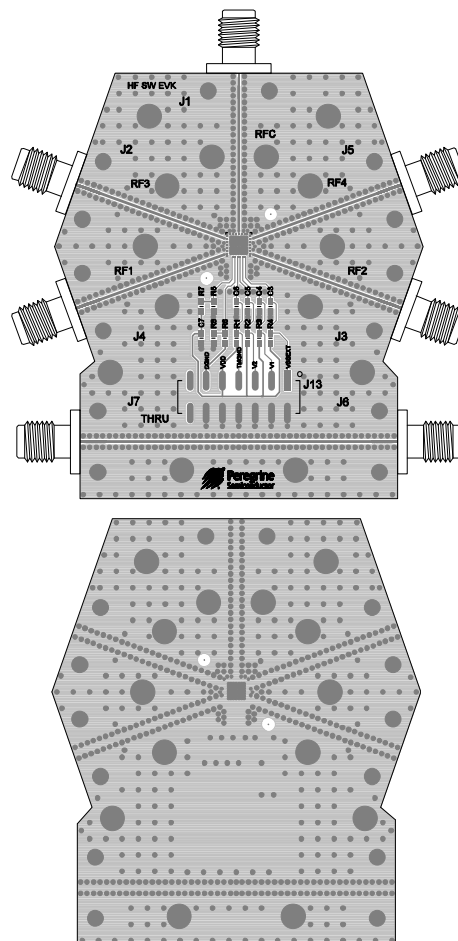

PRT-09205

Figure 21. Evaluation Board Schematic

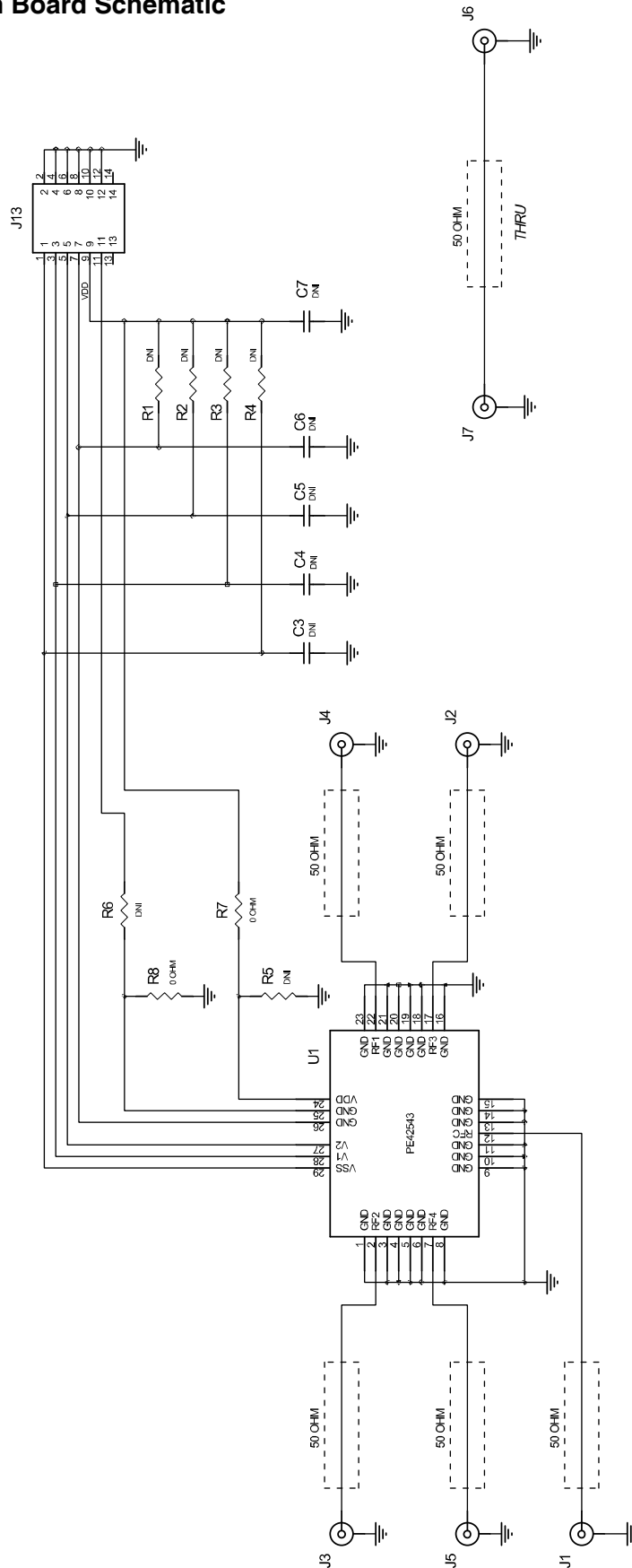

CAUTION: Contains parts and assemblies susceptible to damage by electrostatic discharge (ESD).

DOC-12327

Figure 22. Package Drawing
29-lead 4 × 4 mm LGA

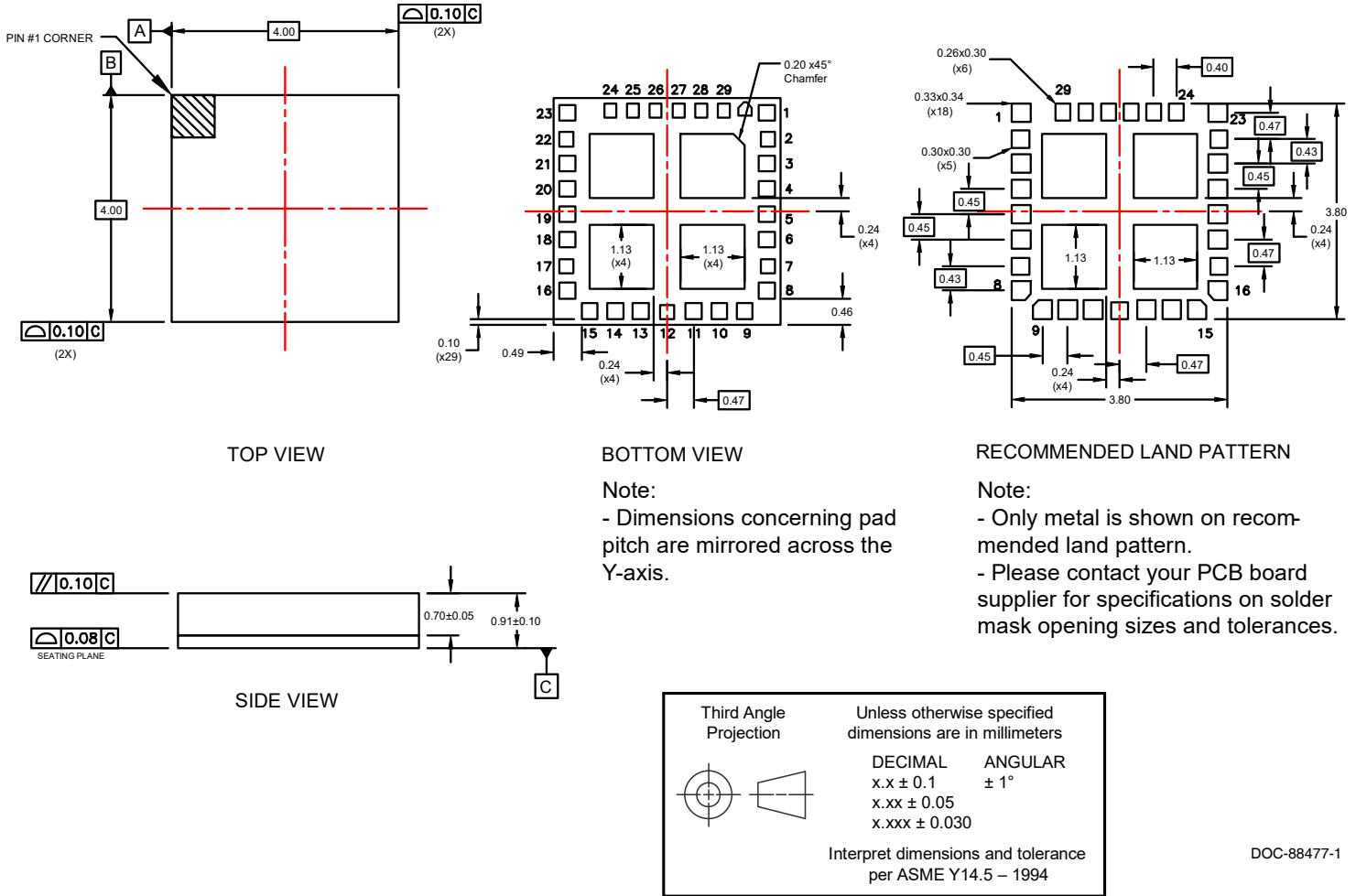

DOC-88477-1

Figure 23. Top Marking Specification

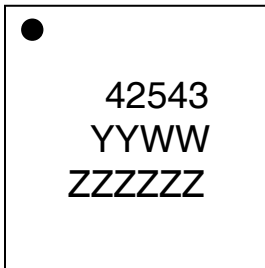

DOC-65745

- = Pin 1 designator
- YYWW = Date code, last two digits of assembly year and work week
- ZZZZZZ = Last six characters of the assembly lot code

Figure 24. Tape and Reel Drawing

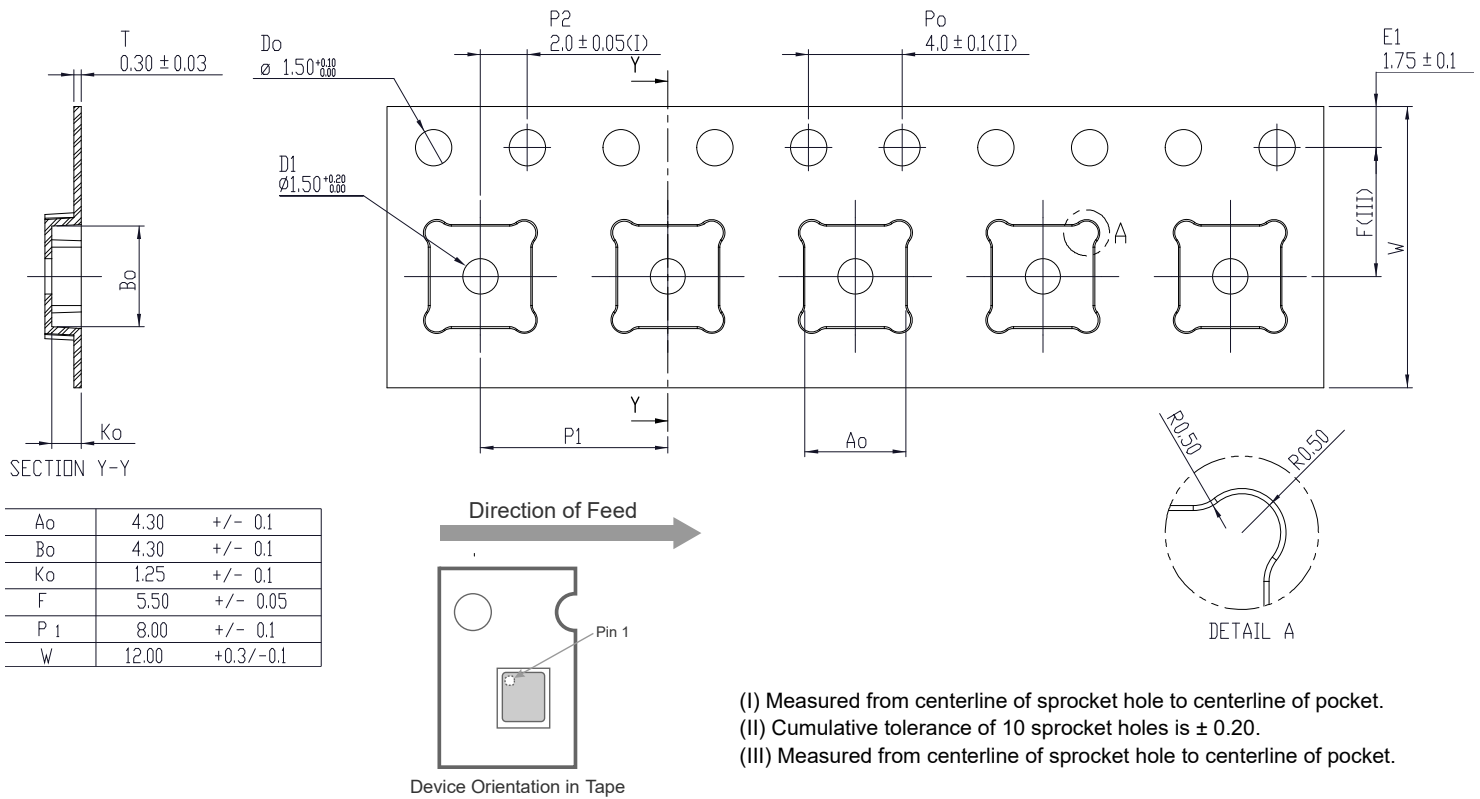

- (I) Measured from centerline of sprocket hole to centerline of pocket.
- (II) Cumulative tolerance of 10 sprocket holes is ± 0.20 .
- (III) Measured from centerline of sprocket hole to centerline of pocket.

Notes:

Not drawn to scale.
All dimensions are in millimeters unless otherwise stated.
Maximum cavity angle 5 degrees.

Table 7. Ordering Information

Order Code	Description	Package	Shipping Method
PE42543C-X	PE42543 SP4T RF switch	29-lead 4 × 4 mm LGA	500 units / T&R
EK42543-04	PE42543 Evaluation kit	Evaluation kit	1 / Box

Sales Contact and Information

For sales and contact information please visit www.psemi.com.

Advance Information: The product is in a formative or design stage. The datasheet contains design target specifications for product development. Specifications and features may change in any manner without notice.
Preliminary Specification: The datasheet contains preliminary data. Additional data may be added at a later date. pSemi reserves the right to change specifications at any time without notice in order to supply the best possible product.
Product Specification: The datasheet contains final data. In the event pSemi decides to change the specifications, pSemi will notify customers of the intended changes by issuing a CNF (Customer Notification Form).
The information in this document is believed to be reliable. However, pSemi assumes no liability for the use of this information. Use shall be entirely at the user's own risk.

No patent rights or licenses to any circuits described in this document are implied or granted to any third party. pSemi's products are not designed or intended for use in devices or systems intended for surgical implant, or in other applications intended to support or sustain life, or in any application in which the failure of the pSemi product could create a situation in which personal injury or death might occur. pSemi assumes no liability for damages, including consequential or incidental damages, arising out of the use of its products in such applications.
The Peregrine Semiconductor name, Peregrine Semiconductor logo and UltraCMOS are registered trademarks and the pSemi name, pSemi logo, HaRP and DuNE are trademarks of pSemi Corporation in the U.S. and other countries.
pSemi products are protected under one or more of the following U.S. patents: patents.psemi.com.